

**HOOKLOADER & SKIPLOADER**

# **MOUNTING ACCESSORIES 2025**

**LIFETIME EXCELLENCE**

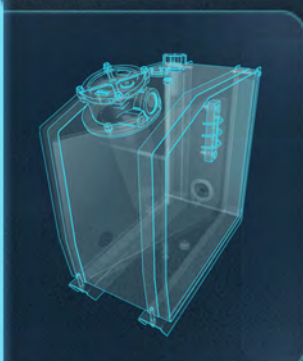

# CONTENT INHALT INDEX

## General accessories / Allgemeines Zubehör / Accessoires généraux

<b>Tank and pump</b> <i>Tank und Pumpe</i> Réservoir et pompe	04 - 09
<b>Underride protection</b> <i>Unterfahrschutz</i> Barre anti-encastrement	10 - 11
<b>Side protection</b> <i>Seitenunterfahrschutz</i> Pare-cyclistes	12 - 13
<b>Mudguards</b> <i>Kotflügel</i> Ailes	14 - 17
<b>Mounting brackets for accessories</b> <i>Montagehalter für Zubehör</i> Support accessoires divers	18 - 21
<b>Toolbox and netbox</b> <i>Werkzeugkasten und Netzbox</i> Coffre à outils et panier à filet	22-23
<b>Screws and nuts</b> <i>Schrauben und muttern</i> Vis et écrous	24
<b>Vision solution</b> <i>Vision lösung</i> Solution rétrovision	25 - 26
<b>PALFINGER marking – speed limit</b> <i>PALFINGER Beschilderung – Speedschild</i> Marquage PALFINGER – disque de vitesse	27-28

## Hookloader installation / Abrollkipper Aufbau / Installation bras

<b>Back cab platform</b> <i>Frontbrücke</i> Passerelle dos cabine	30
<b>Tarp system Palcover H</b> <i>Planensysteme Palcover H</i> Système de bâchage Palcover H	31
<b>Cab control kit</b> <i>Kabinensteuerungssatz</i> Kit commande cabine	32
<b>Container support</b> <i>Container auflager</i> Sellettes	33
<b>SAM advantages</b> <i>SAM Vorteile</i> Avantages SAM	34
<b>Subframe extension</b> <i>Unterrahmensverlängerung</i> Rallonge faux châssis	35
<b>Stabilizer</b> <i>Abstützung</i> Stabilisateur	36

<b>Interface hookloader / crane</b> <i>Abrollkipper-Krananschluss</i> Interface bras / grue	37 - 38
<b>Heavy range mounting kit 13-30 t</b> <i>Schwere Reihe Montage Bausatz 13-30 t</i> Gamme lourde kit de fixation 13-30 t	39 - 50
<b>PH T SCAN mounting kit</b> <i>PH T SCAN Montage Bausatz</i> PH T SCAN Kit fixation	51 - 59
<b>Middle range mounting kit 5-8 t</b> <i>Mittel Reihe Montage Bausatz 5-8 t</i> Gamme moyenne kit de fixation 5-8 t	60 - 72
<b>CiTy Mounting kit</b> <i>CiTy Montagebausatz</i> CiTy Kit fixation	73 - 86
<b>Miscellaneous</b> <i>Sonstiges</i> Divers	87 - 88

## Skiploader installation / Absetzkipper Aufbau / Installation multibenne

<b>Tarp system Palcover S</b> <i>Planensysteme Palcover S</i> Système de bâchage Palcover S	90
<b>ST Mounting kit</b> <i>ST Montagebausatz</i> ST Kit fixation	92 - 98

## Retrofit kits / Nachrüstungssätze / Kits rétrofit

<b>Retrofit kits for hookloader</b> <i>Nachrüstungssätze für Abrollkipper</i> Kits rétrofit pour bras	100 - 102
<b>Retrofit kits for skiploader</b> <i>Nachrüstungssätze für Absetzkipper</i> Kits rétrofit pour multibenne	103 - 105

## Legend / Legende / Légende



**Bolts not included**  
*Schrauben nicht enthalten*  
Visserie non incluse



**Bolts included**  
*Schrauben enthalten*  
Visserie incluse

## Additional information / weitere Informationen / Informations complémentaires

**All certificates available in Paldesk**  
*Prüfzeugnisse verfügbar im Paldesk*  
Certificats disponibles sur Paldesk

PALDESK/Products/Service/Hooklift Europe/Certificates

**Mounting instructions available in Paldesk**  
*Montageleistungen verfügbar im Paldesk*  
Instructions de montage disponibles sur Paldesk

PALDESK/Products/Service/Hooklift Europe/Installation guidelines

# TANK

## TANK

### RÉSERVOIR

#### SELECTION / Auswahl / Sélection



Range Reichweite Gamme (t)	Rated oil flow / Ölmenge / Débit d'huile			Tank size Tank Grösse Taille réservoir (l)
	SDM 110	SD 08 / SDS 150	SDS 180	
	Q (l/min) Max 40 l/min	Q (l/min) Max 90 l/min	Q (l/min) Max 160 l/min	
<3	10 - 12	-	-	20
5	25	-	-	30 - 50
7 - 8	30	40	-	30 - 50
10	-	40	-	50 - 75
12 - 15	-	50-60	-	75 - 100
17 - 30	-	60-80	80-100	120 - 200
17 - 30 (option 6014)	-	-	100 - 130	120 - 200



14-18	-	80	95	120
-------	---	----	----	-----

\* valid with PTO ratio close to 1 and RPM 1000tr/min/ gilt für Übersetzungsverhältnis des Nebenabtriebs von ca. 1 : 1 und RPM 1000 tr/min / valable avec rapport de prise mouvement proche de 1 et un RPM de 1000 tr/min

**Attention: Adapt the selection of pumps and tanks to vehicles and conditions of use.** / Achtung: Die Größe der Pumpe bzw. des Hydrauliktanks müssen auf die jeweiligen Fahrzeuge und Einsatzbedingungen abgestimmt werden. / Attention: Adapter le choix des pompes et réservoirs aux véhicules et aux conditions d'utilisation.

#### KIT CONTENT / Kit Inhalt / Composition du kit

- (1) Tank / Tank / Réservoir
- (2-3) Set of coupling / Verschraubungen / Réservoir
- (4) Stop valve / Absperrhahn / Vanne ¼ tour
- (5) Clamps / Schelle / Colliers

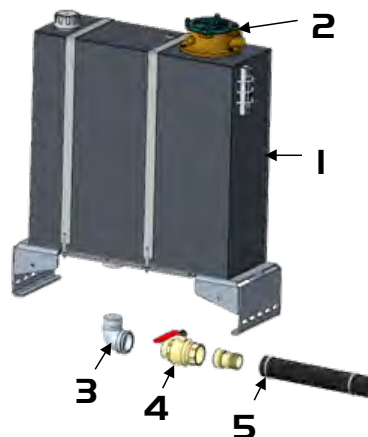

\* Hoses are not supplied in the kit.  
Schläuche sind nicht im Lieferumfang des Bausatzes enthalten.  
Les flexibles ne sont pas fournis.



# WHEELBASE MOUNTED TANKS / TANK IM RADSTAND / Réservoirs dans l'empattement

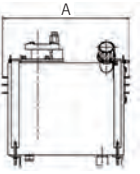
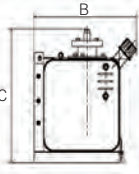

≥ 50 L

Tank kit Bausatz Tank Kit réservoir	Reference kit Teil Nummer Bausatz Référence Kit	A [mm]	B [mm]	C [mm]	Tank only Tank alleine Réservoir seul	Suction Diam. Saugdurch. Diam. aspiration	Return fitting Rückverschraubung Raccord retour	kg
  	50 L (≥ 5 t) M2371057	410	580	580	M63050533	1"1/2	22 L	30
	75 L (≥ 5 t) M2371056	590	580	580	M63050534	2"	28 L	37
	100 L (≥ 5 t) M2371055	560	810	480	M63050535	2"	28 L	43
	130 L (≥ 13 t) M2371863	397	703	733	M63050516	2"	28 L	55
	140 L (≥ 13 t) M2371204	510	710	680	M63050043	2"	28 L	61
	M2375267					2"1/2		
	200 L (≥ 13 t) M2371094	700	700	670	M63050063	2"	28 L	69
	M2375266					2"1/2		

Tank support to order separately  
Halter für Tank separat zu bestellen  
Support réservoir à commander séparément

Quantity  
Menge  
Quantité

Reference  
Teil Nummer  
Référence



<100L  
x1

M9000482

>130L  
x2

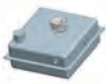

30 L

Tank kit Bausatz Tank Kit réservoir	Reference kit Teil Nummer Bau- satz Référence Kit	A [mm]	B [mm]	C [mm]	Tank only Tank alleine Réservoir seul	Suction Diam. Saugdurch. Diam. aspiration	Return fitting Rückverschraubung Raccord retour	kg
 	30 L (≤ 5 t) M2372020	308	420	420	M63050531	1"	16 S	21

Tank support to order separately  
Halter für Tank separat zu bestellen  
Support réservoir à commander séparément

Unit type  
Gerätetyp  
Type d'équipement

Reference  
Teil Nummer  
Référence



HT 05

M9000825

**NEW!**

HT 07 S - HT 08

M9001225

**NEW!**

General accessories  
Allgemeines Zubehör  
Accessoires généraux

Hookloader  
Abrollkipper  
Polybenne

Skiploader  
Absetzkipper  
Multibenne

Retrofit kits  
Nachrüstungssätze  
Kits rétrofit

# TANK

## TANK

### RÉSERVOIR

20 L

	Tank kit Bausatz Tank Kit réservoir	Reference kit Teil Nummer Bau- satz Référence Kit	A [mm]	B [mm]	C [mm]	Tank only Tank alleine Réservoir seul	Suction Diam. Saugdurch. Diam. aspiration	Return fitting Rückverschraubung Raccord retour	kg
	20 l (≤ 4 t)	M2375139	238	420	420	M63050107	1"	16 S	7

Tank support to order separately Halter für Tank separat zu bestellen Support réservoir à commander séparément	Unit type Gerätetyp Type d'équipement	Designation Bezeichnung Désignation	Reference Teil Nummer Référence
--	---	---	---------------------------------------



CITY Short support M9000567

CITY Long support M9000568

## FRONT MOUNTED TANK / Front Tank / Réservoir frontal

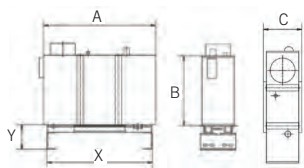

Tank kit Bausatz Tank Kit réservoir	Reference kit Teil Nummer Bau- satz Référence Kit	A [mm]	B [mm]	C [mm]	X [mm]	Y [mm]	Tank only Tank alleine Réservoir seul	Suction Diam. Saugdurch. Diam. aspiration	Return fitting Rückverschraubung Raccord retour	kg
narrow / schmal / étroit 120 l (≥ 13 t) + support / Halter / support	M2372021	722	706	276	828	174	M63050532	2"	28 L	65
120 l (≥ 13 t) + support / Halter / support	M2371731	880	552	294	828	234	M63050512	2"	28 L	65
200 l (≥ 13 t) + support / Halter / support	M2371864	880	924	304	828	234	M63050517	2"	28 L	75

## SUPPORT OFFSET MOUNTED TANK / Seitliche Halter für Front Tank / Support réservoir frontal déporté

Tank support to order separately  
Halter für Tank separat zu bestellen  
Support réservoir à commander séparément



Reference  
Teil Nummer  
Référence



30

M9000701

## FRONT MOUNTED TANK V SHAPE / V Kontur Front Tank / Réservoir frontal incurvé

Tank kit Bausatz Tank Kit réservoir	Reference kit Teil Nummer/Bausatz Référence Kit	A [mm]	B [mm]	C [mm]	Suction Diam. Saugdurch. Diam. aspiration	Return fitting Rückverschraubung Raccord retour	kg
150 l (HT-HP-HC >=17t) + support / Halter / support	M9001432	1019	1454	250	2"	28 l	118



**NEW!**

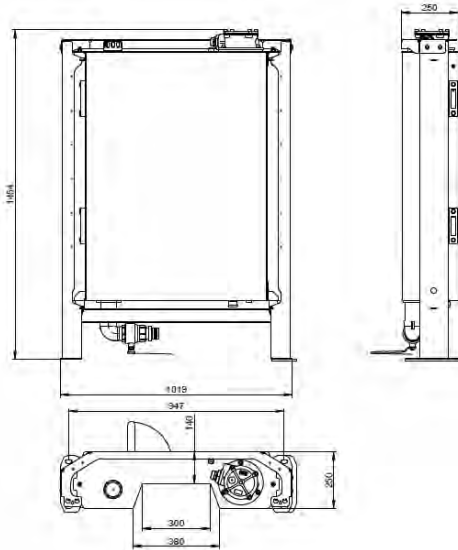

## SUCTION HOSES / Saugschlauch / Durite d'aspiration

Reference Teil Nummer Référence	Ø ["]	ID / OD (mm)	Length [m] Länge Longueur
M63030897	1"	25 / 35	25
M63031144	1" 1/2	38 / 48	25
M63030898	2"	51 / 65	20
M63031247	2" 1/2	63 / 70	20



## HIGH PRESSURE FILTER / Hochdruckfilter / Filtre haute pression

Designation Bezeichnung Désignation	Reference Teil Nummer Référence	P max	Q max	kg
High pressure filter kit / Hochdruckfilter Bausatz / Kit filtre haute pression	M2375346	365 bar	110 L/min	11



### PISTON PUMPS HYDRO LEDUC / Hydro Leduc Kolbenpumpe / Pompes à pistons Hydro Leduc



Pump kit <i>Bausatz Pumpe</i> Kit Pompe	Reference <i>Referenz</i> Référence	Standard <i>Norm</i> Norme	Displacement <i>Volumen</i> Cylindrée [cm <sup>3</sup> /tr]	Coupling <i>Verschraubung</i> Raccords		kg	Pump alone <i>Pumpe alleine</i> Pompe seule
				Suction <i>Rücklauf</i> Aspiration	Pression <i>Druck</i> Pression		
PA 25	M2371172	DIN 5462	28	2"	3/4"	17	M63060909
PA 32	M2371234	DIN 5462	34	2"	3/4"	17	M63060910
PA 40	M2371233	DIN 5462	43	2"	3/4"	17	M63060911
PA 50	M2371239	DIN 5462	50	2"	3/4"	17	M63060912
PAC 65	M2371101	DIN 5462	68	2"	3/4"	19	M63060932
PAC 80	M2371102	DIN 5462	78	2"	3/4"	19	M63060931
PAC 2x40	M2371236	DIN 5462	2x39	2"	3/4"	19	M63060935
PA 2x57	M2371200	DIN 5462	2x57	2"	3/4"	20	M63060924
XPi 18	M2372022	DIN 5462	18	1 1/2"	3/4"	11	M63061198
XPi 25	M2375300	DIN 5462	25	1 1/2"	3/4"	11	M63061257
XPi 32	M2375331	DIN 5462	32	1 1/2"	3/4"	11	M63061264
XPi 41	M2375332	DIN 5462	41	1 1/2"	3/4"	11	M63061265
XPi 50	M2371733	DIN 5462	50	1 1/2"	3/4"	12	M63061225
XPi 63	M2371732	DIN 5462	63	2"	3/4"	12	M63060938
XPi 80	M2371310	DIN 5462	80	2"	1"	18	M63060937
XPi 108	M2371305	DIN 5462	108	2"	1"	18	M63060936
	M2375262			2" 1/2"	M63061230		
XPi 130	M2372069	DIN 5462	130	2"	1"	-	M63061222
	M2375263			2" 1/2"	M63061231		
By-pass kit							
By-pass XPi 18 - 63 24 V	M2375301	-	-	-	-	-	-
By-pass XPi 80 - 130 24 V	M2375302	-	-	-	-	-	-

**NEW!**

**NEW!**

**NEW!**

### LOW NOISE PUMP FOR ePTO / Leise Pumpe für ePTO / Pompe bruit réduit pour ePTO



XRE 41	M2375348	DIN 5462	41	2"	3/4"	18	-
XRE 63	M2375459	DIN 5462	63	2"	3/4"	18	-

**NEW!**

## PISTON PUMPS REXROTH / Rexroth Kolbenpumpe / Pompes à pistons Rexroth

**Rexroth**  
Bosch Group

Pump kit Bausatz Pumpe Kit Pompe	Reference Referenz Référence	Standard Norm Norme	Displacement Volumen Cylindrée [cm <sup>3</sup> /tr]	Coupling Verschraubung Raccords		kg	Pump alone Pumpe alleine Pompe seule
				Suction Rücklauf Aspiration	Pression Druck Pression		
A17FO 45	M2371699	DIN 5462	45	2"	3/4"	8	M63061136
A17FO 63	M2371700	DIN 5462	63	2"	3/4"	9	M63061137
A17FO 80	M2371701	DIN 5462	80	2"	3/4"	11,6	M63061138
A17FO 107	M2371702 M2375264	DIN 5462	107	2" 2"1/2	3/4"	14,5	M63061139
By-pass kit							
By-pass A17FO 63 24 V	M2375303	-	-	-	-	-	-
By-pass A17FO 80 24 V	M2375304	-	-	-	-	-	-
By-pass A17FO 107 24 V	M2375305	-	-	-	-	-	-



## LOW NOISE PUMP FOR ePTO / Leise Pumpe für ePTO / Pompe bruit réduit pour ePTO



PGH4-40	M2375354	DIN 5462	40	2"	3/4"	26	-
---------	----------	----------	----	----	------	----	---

Pmax 31.5MPa

## GEAR PUMPS / Zahnpumpe / Pompes à engrenages

**OMFB**  
HYDRAULIC COMPONENTS

Pump kit Bausatz Pumpe Kit Pompe	Reference Referenz Référence	Shaft Standard Welle Norm Norme Arbre	Displacement Volumen Cylindrée [cm <sup>3</sup> /tr]	Coupling Verschraubung Raccords		kg	Pump alone Pumpe alleine Pompe seule
				Suction Rücklauf Aspiration	Pression Druck Pression		
NPLH UNI 13DIN 12	M2375307	UNI	11,92	1/2"	1/2"	5.14	-
NPLH UNI 13DIN 16	M2375308	UNI	16,03	1/2"	1/2"	5.58	-
NPLH UNI 13DIN 20	M2375309	UNI	20.1	1/2"	1/2"	5.84	-



Pmax 28M Pa

## 2 WAYS VALVE FOR LS PUMP SHARING / 2 Wege Ventil für LS Pumpe Verteilung / Vanne 2 voies pour partage pompe LS

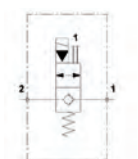

2 ways valve 24VDC M2371771

General accessories  
Allgemeines Zubehör  
Accessoires généraux

Hookloader  
Abrollkipper  
Polybenne

Skiploader  
Absettkipper  
Multibenne

Retrofit kits  
Nachrüstungssätze  
Kits rétrofit

# UNDERRIDE PROTECTION

## UNTERFAHRSCHUTZ

### BARRE ANTI-ENCASTREMENT

Conform to 58R03

URP brackets / UFS Montagekonsolen / Flasques BAE

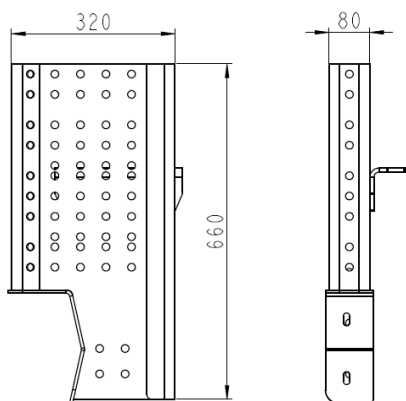

URP Brackets UFS Montagekonsolen Flasques BAE	Reference Teil Nummer Référence	kg
Not drilled / Ungebohrt / Non percées Other brands / Andere Marken / Autres marques DAF CF - XF	M9001117	44
RENAULT D>16T - D WIDE - T - C - K VOLVO FM(X) - FH	M9001040	44
MAN TGM - TGS - TGX	M9001039	43
MERCEDES AROCS - ANTOS - ACTROS	M9001041	43
IVECO SWAY - XWAY - TRAKKER	M9001042	43
SCANIA P - G - R	M9001043	43



**!** Check compatibility with truck 16t>GVW>19t / Kompatibilität mit LKW prüfen 16t>LKW>19t / Vérifier la compatibilité avec les châssis 16t>PTAC>19t.

**VALID FOR / GÜLTIG FÜR / VALABLE POUR :**

Trucks category / LKW-Kategorie / Catégories de camion



GVW > 19t with bolts Ø14mm  
ZGG >19t mit Schrauben Ø14mm  
PTAC >19t avec boulons Ø14mm

**TELESCOPIC URP (N3) / Teleskop UFS (N3) / BAE Télescopique (N3)**

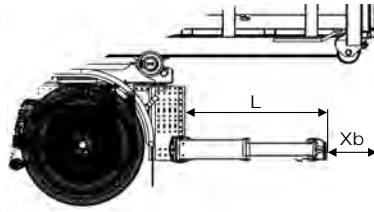

**TELESCOPIC HYDRAULIC OPERATED / Teleskop hydraulisch / Télescopique hydraulique (N3)**



Designation Bezeichnung Désignation	L [mm]	Stroke [mm] Hub Course	Reference Teil Nummer Référence	Xb [mm]	kg
T-XL	1268	1055	M2093150	300	138
T-L	1068	855	M2093154	300	133
T-M	868	655	M2093155	300	129
T-S	568	355	M2093156	300	121



Hookloader option code required / Option für Abrollkipper erforderlich / Option nécessaire sur le bras: **6707**

**TELESCOPIC MANUALLY OPERATED / Teleskop manuell / Télescopique manuelle (N3)**



Designation Bezeichnung Désignation	L [mm]	Stroke [mm] Hub Course	Reference Teil Nummer Référence	Xb [mm]	kg
TM-XL	1268	1055	M2093152	300	122
TM-L	1068	855	M2093157	300	118
TM-M	868	655	M2093158	300	113
TM-S	568	355	M2093159	300	105



Hookloader option code required / Option für Abrollkipper erforderlich / Option nécessaire sur le bras: **6712**

**ARTICULATED HYDRAULIC OPERATED / Klappbare hydraulisch / Articulée hydraulique (N3)**

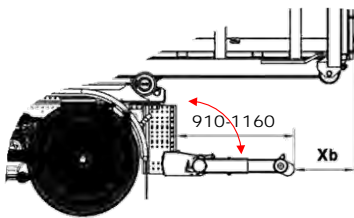

Designation Bezeichnung Désignation	Reference Teil Nummer Référence	Xb [mm]	kg
URP A UFS A BAE A	M2093147	300	185



L out setting step / Einstellschritt / Pas de réglage: 50mm  
Hookloader option code required / Option für Abrollkipper erforderlich / Option nécessaire sur le bras: **6707**

**FIXED / Starr / Fixe (N3)**

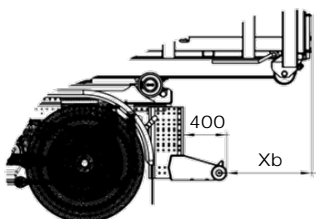

Designation Bezeichnung Désignation	Reference Teil Nummer Référence	Xb [mm]	kg
URP A UFS A BAE A	M2093151	300	70



General accessories  
Allgemeines Zubehör  
Accessoires généraux

Hookloader  
Abrollkipper  
Polybenne

Skiploader  
Absetzkipper  
Multibenne

Retrofit kits  
Nachrüstungssätze  
Kits retrofit

# SIDE PROTECTION

## SEITENUNTERFAHRSCHUTZ

## PARE-CYCLISTES





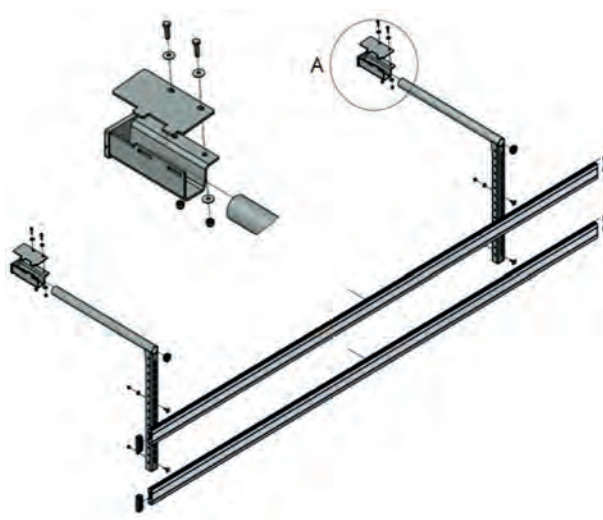
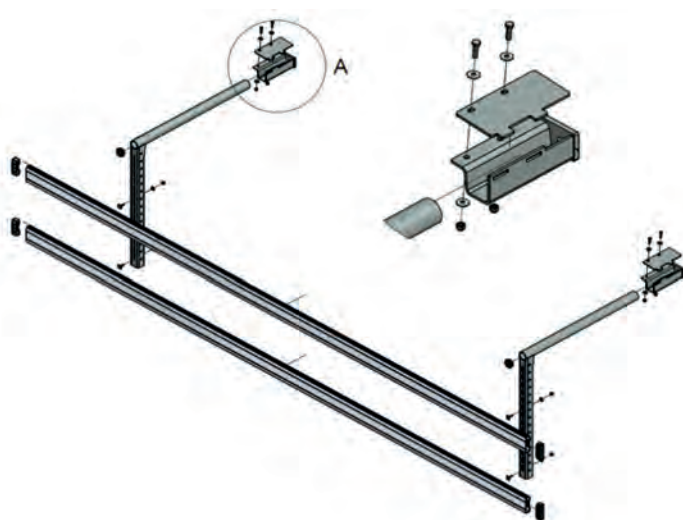
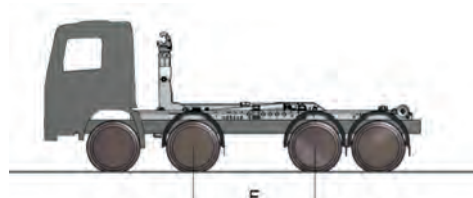
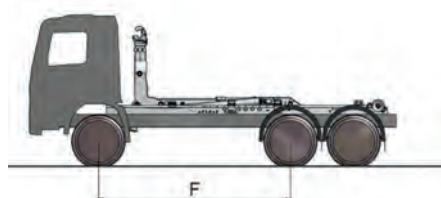





Conform to 73R01

KIT / Bausatz / Kit

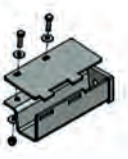
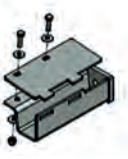

Designation Bezeichnung Désignation	Reference Teil Nummer Référence	F [mm]	kg
<b>Kit 4 fixed supports + 4 aluminium profiles 3,5 m</b> Bausatz 4 Halter + 4 Aluminium Profile 3,5 m Kit 4 supports fixes + 4 barres Alu 3,5 m	M9000400	3901 < F < 5000	60
<b>Kit 4 fixed supports + 2 aluminum profiles 5 m</b> Bausatz 4 Halter + 2 Aluminium Profile 5 m Kit 4 supports fixes + 2 barres aluminium 5 m	M9000401	F < 3900	73
<b>Kit 6 fixed supports + 4 aluminium profiles 5 m</b> Bausatz 6 Halter + 4 Aluminium Profile 5 m Kit 6 supports fixes + 4 barres aluminium 5 m	M9000402	F > 5000	126
<b>Kit 4 fixed supports + 2 aluminium profiles 3,5 m</b> Bausatz 4 Halter + 2 Aluminium Profile 3,5 m Kit 4 supports fixes + 2 barres aluminium 3,5 m	M9000403	PTAC < 8 t	47
<b>Kit 4 fixed supports + 4 aluminium profiles 3,5 m black</b> Bausatz 4 Halter + 4 Aluminium Profile 3,5 m schwarz Kit 4 supports fixes + 4 barres aluminium 3,5 m noir	M9000399	3901 < F < 5000	50

## SINGLE PARTS / Einzelteile / Pièces détachées

	Designation Bezeichnung Désignation	Reference Teil Nummer Référence
	<b>Kit 1 single support + accessories</b> <i>Bausatz 1 Halter mit Zubehör</i> Kit 1 support unique + accessoires	M9000404
	<b>Articulation kit for side protection</b> <i>Bausatz klappbare seitliche Schutzvorrichtung</i> Kit articulation pare-cycliste	M9000405
	<b>Angled bracket kit for extension</b> <i>Bausatz Winkelhalter mit Schellen</i> Kit support coudé unique	M9000425
	<b>Angled bracket kit</b> <i>Bausatz Winkelhalter</i> Kit support coudé	M9000424
	<b>Aluminium profile L3500 mm</b> <i>Aluminium profil L3500 mm</i> Profil aluminium L3500 mm	M62010651
	<b>Aluminium profile L5000 mm</b> <i>Aluminium profil L5000 mm</i> Profil aluminium L5000 mm	M62010652
	<b>Fixation bracket kit left</b> <i>Bausatz Halter links</i> Kit support de fixation gauche	M9000423
	<b>Fixation bracket kit right</b> <i>Bausatz Halter rechts</i> Kit support de fixation droit	M9000500
	<b>Angle profile H100 mm, L100 mm</b> <i>Winkelabschluss H100 mm, L100 mm</i> Profil d'angle H100 mm, L100 mm	M62010615
	<b>Angle profile H100 mm, L500 mm</b> <i>Winkelabschluss H100 mm, L500 mm</i> Profil d'angle H100 mm, L500 mm	M62010714
	<b>Rear cap</b> <i>Abschluss</i> Bouchon AR	M62010616

# MUDGUARDS

## KOTFLÜGEL

## AILES





The fixations are now part of the kits  
 Die Befestigungen sind dann Teil den Bausätze  
 Les fixations font maintenant partie du kit

### KIT / Bausatz / Kit

		Designation Bezeichnung Désignation	Reference Teil Nummer Référence	Width [mm] Breite Largeur	Length [mm] Länge Longueur	kg
 		<b>2 axles aluminium mudguards kit with reflecting tape support</b> 2 Achsen Alu-Kotflügel Bausatz mit Halterung für reflektiv Aufkleber Kit ailes alu double essieux avec support pour bande réfléchissante	M9001355	650	2700	60
		<b>2 axles aluminium mudguards kit</b> 2 Achsen Alu-Kotflügel Bausatz Kit ailes alu double essieux	M9001375	690	2700	60
 		<b>1 axle aluminium mudguards kit</b> 1 Achse Alu-Kotflügel Bausatz Kit ailes alu simple essieu	M9001356	650	1280	46
		<b>1 axle aluminium mudguards kit</b> 1 Achse Alu-Kotflügel Bausatz Kit ailes alu simple essieu	M9001357	450	1350	45
 		<b>2 axles plastic mudguards kit</b> 2 Achsen Plastik-Kotflügel Bausatz Kit ailes plastique double essieux	M9001358	650	2700	77
 		<b>1 axle plastic adjustable mudguards kit</b> 1 Achse Plastic einstellbare Kotflügel Bausatz Kit ailes plastiques ajustables simple essieu	M9001359	650	1280	56
 		<b>Twin tire plastic mudguards kit</b> Zwillingsreifen Plastik-Kotflügel Bausatz Kit ailes plastique monte jumelée	M9001363	580	1285 GVW 8-10 t	54
 		<b>Twin tire plastic mudguards kit</b> Zwillingsreifen Plastik-Kotflügel Bausatz Kit ailes plastique monte jumelée	M9001362	530	1020 GVW 3,5 -7,5 t 205-215/75/ R17,5	50
 	Ø 36 mm	<b>Twin tire plastic mudguards kit</b> Zwillingsreifen Plastik-Kotflügel Bausatz Kit ailes plastique monte jumelée	M9001361	530	860 GVW 3,5 -7,5 t 205-215/75/ R16	30
 	Ø 36 mm	<b>Twin tire plastic mudguards kit</b> Zwillingsreifen Plastik-Kotflügel Bausatz Kit ailes plastique monte jumelée	M9001360	485	1020 GVW 3,5 -7,5 t 205-215/75/ R14-16	32

Conform to 2011R0109

## MUDFLAPS / Schmutzfänger / bavettes

	Designation Bezeichnung Désignation	Reference Teil Nummer Référence	 [mm]	 kg
	<b>Aluminium separation &amp; anti-spray mudflaps kit</b> <i>Aluminium Trennung mit Spritzlappen Bausatz</i> Kit séparation aluminium avec bavettes anti-projection	M9001364	650x900 <b>NEW!</b>	18,7
	<b>Separation &amp; anti-spray mudflaps kit for PVC or alu fenders</b> <i>Trennung mit Spritzlappen Bausatz geeignet für PVC oder Alu Kotflügel</i> Kit séparation avec bavettes anti-projection pour ailes PVC ou alu	M9001341	650x900 <b>NEW!</b>	8,8
	<b>Anti-spray mudflaps kit</b> <i>Anti-spray Spritzlappen Bausatz</i> Kit bavette anti-projection	M9001474	650x900 <b>NEW!</b>	7
	<b>Anti-spray mudflaps kit</b> <i>Anti-spray Spritzlappen Bausatz</i> Kit bavette anti-projection	M9000761	600x900	7
	<b>Anti-spray mudflaps kit</b> <i>Anti-spray Spritzlappen Bausatz</i> Kit bavette anti-projection	M9000762	400x700	6

## MUDFLAPS / Schmutzfänger / bavettes



<b>Slick mudflaps kit</b> <i>Spritzlappen Bausatz</i> Kit bavette lisse	M9000705	600x400	3
---	----------	---------	---

## TUBE BRACKETS / Rohrhalterungen / Fixations tube

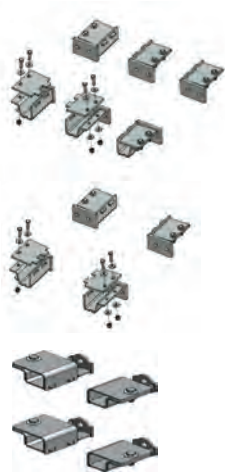

<b>Tube brackets kit (Tandem right &amp; left)</b> <i>Rohrhalterungen Bausatz (Tandem rechts &amp; links)</i> Kit fixations pour tube (Tandem droite et gauche)	M9800214	Ø42	9
<b>Tube brackets kit (single fender right &amp; left)</b> <i>Rohrhalterungen Bausatz (Einzel Kotflügel rechts &amp; links)</i> Kit fixations pour tube (Aile simple droite et gauche)	M9800213	Ø42	6
<b>Tube brackets kit (single fender right &amp; left)</b> <i>Rohrhalterungen Bausatz (Einzel Kotflügel rechts &amp; links)</i> Kit fixations pour tube (Aile simple droite et gauche)	M9000566	Ø34	2,3

General accessories  
Allgemeines Zubehör  
Accessoires généraux

Hookloader  
Abrollkipper  
Polybenne

Skiploader  
Absetzkipper  
Multibenne







Retrofit kits  
Nachrüstungssätze  
Kits rétrofit

# MUDGUARDS







## KOTFLÜGEL

### AILES

#### RETAILED MUD GUARDS / Einzelkotflügel / Ailes au détail

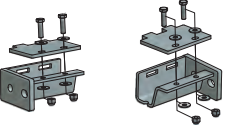
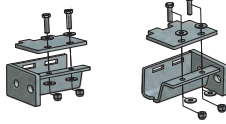
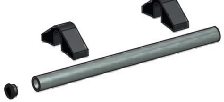
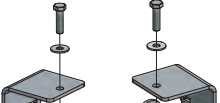
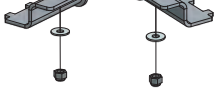
	Designation Bezeichnung Désignation	Reference Teil Nummer Référence	Width [mm] Breite Largeur	Length [mm] Länge Longueur	kg
	<b>2 axles aluminium mudguard with reflecting tape support</b> <i>2 Achsen Alu-Kotflügel für reflektiv Aufkleber</i> Aile alu double essieux avec support pour bande réfléchissante	M62010621	650	2700	20
	<b>2 axles aluminium mudguard</b> <i>2 Achsen Alu-Kotflügel</i> Aile alu double essieux	M62010832	690	2700	22
	<b>1 axle aluminium mudguard</b> <i>1 Achse Alu-Kotflügel</i> Aile alu simple essieu	M62010622	650	1280	12,5
  For / Für / Pour 8X4	<b>1 axle aluminium mudguard</b> <i>1 Achse Alu-Kotflügel</i> Aile alu simple essieu	M62010723	450	1280	12
	<b>2 axles plastic mudguard</b> <i>2 Achsen Plastik-Kotflügel</i> Aile plastique double essieux	M62010736 <b>NEW!</b>	650	2700	11
	<b>1 axle plastic adjustable mudguard</b> <i>1 Achse einstellbare Plastik-Kotflügel</i> Aile plastique ajustable simple essieu	M62010179	650	1280	5
	<b>Twin tire plastic mudguard</b> <i>Zwillingsreifen Plastik-Kotflügel</i> Aile plastique monte jumelée	M62010947	580	1285 GVW 8-10 t	6
	<b>Twin tire plastic mudguard</b> <i>Zwillingsreifen Plastik-Kotflügel</i> Aile plastique monte jumelée	M62010946	530	1020 GVW 3,5-7,5 t 205-215/75/ R17,5	6
	<b>Twin tire plastic mudguard</b> <i>Zwillingsreifen Plastik-Kotflügel</i> Aile plastique monte jumelée	M62010857	530	860 GVW 3,5-7,5 t 205-215/75/ R16	2,5
	<b>Twin tire plastic mudguard</b> <i>Zwillingsreifen Plastik-Kotflügel</i> Aile plastique monte jumelée	M62010888	485	1020 GVW 3,5-7,5 t 205-215/75/ R14-16	6









## KIT / Bausatz / Kit

	Designation Bezeichnung Désignation	Reference Teil Nummer Référence	kg
	<b>Tube mounting kit for aluminium mudguard Ø 42</b> <i>Bausatz Halterrohr für Aluminium-Kotflügel Ø 42</i> KIT tube de fixation pour aile aluminium Ø 42	M9000501	2,5
	<b>Tube mounting kit for adjustable plastic mudguard Ø42</b> <i>Bausatz Halterrohr für einstellbare Plastik-Kotflügel Ø42</i> Kit tube fixation aile plastique réglable Ø42	M9000502	2,6
	<b>2 tubes mounting kit for plastic mudguard Ø42</b> <i>Bausatz 2 Halterrohr für Plastik-Kotflügel Ø42</i> Kit 2 tubes fixation aile plastique Ø42	M9000692 <span style="border: 2px solid red; padding: 2px; font-weight: bold; color: white;">NEW!</span>	4
	<b>Mounting bracket - left Ø 42</b> <i>Halter für Kotflügel - links Ø 42</i> Bride de fixation - gauche Ø 42	M9000503	1,6
	<b>Mounting bracket - right Ø 42</b> <i>Halter für Kotflügel - rechts Ø 42</i> Bride de fixation - droite Ø 42	M9000504	1,6
	<b>Tube mounting kit for plastic mudguard Ø 34</b> <i>Bausatz Halterrohr für Plastik-Kotflügel Ø 34</i> Kit tube de fixation pour aile plastique Ø 34	M9000833	1,8
	<b>Mounting bracket - left Ø 34</b> <i>Halter für Kotflügel - links Ø 34</i> Bride de fixation - gauche Ø 34	M9000532	0,7
	<b>Mounting bracket - right Ø 34</b> <i>Halter für Kotflügel - rechts Ø 34</i> Bride de fixation - droite Ø 34	M9000533	0,7
	<b>Aluminium corners kit for reflective tape</b> <i>Aluminiumecke Bausatz für reflektierendes Klebeband</i> Kit cornières aluminium pour bande réfléchissante	M9001207	1
	<b>Rubber band for reflective tape on PVC mudguards</b> <i>Gummiband für reflektiv Aufkleber am PVC Kotflügel</i> Bande Caoutchouc pour bande réfléchissante	M5333141	1
	<b>Aluminium corners kit for reflective tape</b> <i>Aluminiumecke Bausatz für reflektierendes Klebeband</i> Kit cornières aluminium pour bande réfléchissante  For PHT05-HT07S-HT08 models	M9001287	4,6

# MOUNTING BRACKETS FOR ACCESSORIES

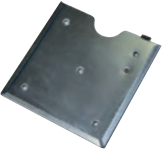
## MONTAGEHALTER FÜR ZUBEHÖR SUPPORT ACCESSOIRES DIVERS

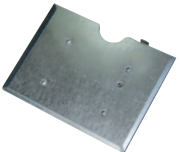
### SUPPORT FOR ADR PLATE / Halter für ADR-Tafel / Support plaque ADR

	Designation Bezeichnung Désignation	Reference Teil Nummer Référence
	<b>Side support for ADR plate</b> <i>Halter seitlich für ADR-Tafel</i> Support latéral pour plaque ADR	 M5331105_80036
	<b>Rear support for ADR plate</b> <i>Halter hinten für ADR-Tafel</i> Support arrière pour plaque ADR	 M5331628_80036
	<b>ADR plate support lozenge</b> <i>ADR-Tafelhalter rautenförmig</i> Support plaque ADR losange	 M62010247
	<b>ADR plate support rectangle</b> <i>ADR-Tafelhalter rechteckig</i> Support plaque ADR rectangle	 M62010248

### SUPPORT FOR LOWER MAIN VALVE / Adapter Halter für niedrige Position des Steuerschiebers / Support distributeur surbaissé



**Support for lower main valve (- 85mm)**  
*Adapter für niedrige Steuerschieberposition (- 85mm)*  
 Support pour distributeur surbaissé (- 85mm)



M5328778\_80030

\* not needed on HT-HP-HC-PH T / nicht notwendig am HT-HP-HC-PH T / pas nécessaire sur les HT-HP-HC-PH T

### REAR HYDRAULIC CONNECTIONS SUPPORT / Bausatz Halter für hydraulische Anschlüsse / Support pour prises hydrauliques arrières



**Rear hydraulic connections support**  
*Bausatz-Halter für hydraulische Schnellkupplungen*  
 Support pour prises hydrauliques arrières



M5331627\_80061

## ELECTRIC CONNECTIONS SUPPORT / Halter für elektrische Anschlüsse / Support pour prises électriques arrières et mains d'air

	Designation Bezeichnung Désignation	Reference Teil Nummer Référence
	<b>Electric connections support</b> <i>Bausatz Halter E-Kupplung</i> Support pour prises électriques et mains d'air	M5331647_80061
	<b>Additional electric connection support</b> <i>Zusätzlicher Bausatz-Halter für E-Kupplung</i> Support additionnel pour prise électrique	M5332192_80061
	<b>Additional hydraulic, electric and pneumatic connection support</b> <i>Zusätzliche hydraulische, elektrische und pneumatische Anschlüsse</i> Support additionnel pour prise hydraulique, électrique et pneumatique	M5337954_80061

## REAR LIGHTS SUPPORT KIT / Rückleuchten Halterbausatz / Kit support de feux arrières

	Designation Bezeichnung Désignation	Reference Teil Nummer Référence	kg	KTL protected RAL 9005
	<b>Rear lights support kit</b> <i>Rückleuchten-Halter</i> Kit supports de feux AR	M9000481	20	

## REAR LIGHTS SUPPORT KIT WITH TRAILER PLUGS IN LINE / Rückleuchten Halterbausatz mit Anhängerstecker in Line / Kit support de feux arrières avec coupleurs remorques alignés

	<b>Rear lights support kit for horizontal trailer plugs</b> <i>Bausatz Halter Rückleuchten für horizontale Anhängerkupplungen</i> Kit support feux arrière pour prises remorque horizontales	M9001291	19	KTL protected RAL 9005
	<b>Left rear lights support kit for horizontal trailer plugs</b> <i>Halter Rückleuchten für horizontale Anhängerkupplung</i> Support gauche feux arrière pour prises remorque horizontales	M5340257_80061	6	

## REINFORCED REAR LIGHTS SUPPORT KIT / Verstärkter Rückleuchten Halterbausatz / Kit support renforcé de feux arrières

	<b>Reinforced rear light supports kit</b> <i>Verstärkter Halter Rückleuchten Bausatz</i> Kit support renforcé de feux arrières	M9001417	26	KTL protected RAL 9005
	<b>Standalone support for reinforced rear light support</b> <i>Eigenständige Halterung für verstärkte Rücklichthalterung</i> Support autonome pour support renforcé de feux arrières	M5341770_80061	3	



# MOUNTING BRACKETS FOR ACCESSORIES

## MONTAGEHALTER FÜR ZUBEHÖR SUPPORT ACCESSOIRES DIVERS

**EXTINGUISHER AND WORKING LIGHTS SUPPORT / Halter für Feuerlöscher und Arbeitsscheinwerfer / Supports coffre extincteur et phare de travail**

	Designation Bezeichnung Désignation	Reference Teil Nummer Référence	 kg	
	<p><b>Support kit for extinguisher between single mudguard (Palfinger tubes for mudguard are required)</b>  <i>Halterbausatz für Feuerlöscher zwischen einzelne Kotflügel            (Palfinger Halterung für Kotflügel ist nötig)</i>            Kit support extincteur entre ailes simples            (Le tube support Palfinger est nécessaire)</p> <p><b>Zn Ni protected</b>            For PHT-HT models</p>	M9001328	13,5	
	<p><b>Vertical extinguisher support</b>  <i>Vertikal Halter für Feuerlöscher</i>            Support extincteur vertical</p> <p><b>Zn Ni protected</b></p>	M5339887_80030	3,6	
	<p><b>Worklight support for vertical position</b>  <i>Arbeitsscheinwerfer Halter für vertikale Position</i>            Support phare de travail pour position verticale</p>	M5331980_80061	0,8	
	<p><b>Horizontal extinguisher support</b>  <i>Horizontal Halter für Feuerlöscher</i>            Support extincteur horizontal</p> <p><b>Zn Ni protected</b></p>	PHT-HT 18-24 / HP 17-20 / HC 21  HT 26-30 / HP 24	M5340150_80030  M5340742_80030	2,8  2,8
	<p><b>Horizontal extinguisher support</b>  <i>Horizontal Halter für Feuerlöscher</i>            Support extincteur horizontal</p> <p><b>Zn Ni protected</b>            For T-P-S models</p>	M5340151_80030	2,8	
	<p><b>6 kg powder extinguisher class ABC (Instructions in French)</b>  <i>6 kg Pulver Feuerlöscher Klasse ABC            (Französische Anweisungen)</i>            Extincteur 6 kg poudre classe ABC            (consignes en français)</p>	M66000031	9	
	<p><b>Plastic extinguisher box horizontal</b>  <i>Feuerlöscherkasten horizontal</i>            Coffre extincteur plastique horizontal</p>	M66000107	2,8	
	<p><b>Plastic extinguisher box vertical</b>  <i>Feuerlöscherkasten vertikal</i>            Coffre extincteur plastique vertical</p>	M66000041	2,9	



## WATER TANK / Wassertank / Réservoir d'eau

	Designation Bezeichnung Désignation	Reference Teil Nummer Référence	kg
	<b>30 L water tank kit (Fixation between mud guards)</b> 30 L Wassertank Bausatz (Montiert zwischen Kotflügel) Kit réservoir d'eau 30 L (Montage entre ailes)  Zn Ni protected	M9001336	5,5
	<b>30L water tank kit (Fixation on frame)</b> 30 L Wassertank (Montiert am Chassis) Kit réservoir d'eau 30 L (Montage sur châssis)  Zn Ni protected	M9001335	5
	<b>Embedded soap dispenser / Inklusiv Seifenspender / Distributeur de savon intégré</b>		

## BLIND SPOT WARNING / Angle Mort Warnungsschild / Avertisseur angle mort

**Mandatory in France for all truck GVW above 3,5t**  
Pflicht im Frankreich für alle Fahrzeuge über 3,5t Gesamtgewicht  
Obligatoire en France pour les camions avec PTC supérieur à 3,5t



	Designation Bezeichnung Désignation	Reference Teil Nummer Référence	kg
	<b>Elbow support for "Angle mort" shield</b> Winkel Halterung für « Angle mort » Schild Support angle mort en équerre	M5339084	1,66
	<b>"Angle mort" Sticker</b> « Angle Mort » Aufkleber Autocollant « Angle mort »	M62010911	-

## « A » SHIELD / « A » SCHILD / PANNEAU « A »

	<b>Vertical foldable support for "A" shield</b> Vertikal klappbare Halterung für « A » Schild Support pliable vertical pour panneau « A »	M62010932	0,5
--	---	-----------	-----

# TOOLBOX

## WERKZEUGKASTEN

### COFFRE À OUTILS

CONFORM TO ECE Regulation N°73R01

TOOLBOX / Werkzeugkasten / Coffre à outils

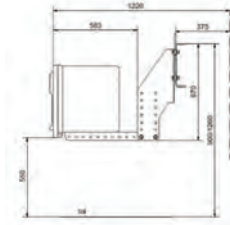
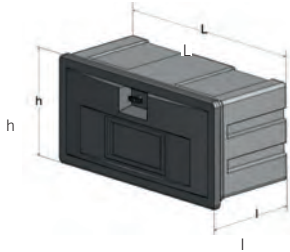

Designation  
Bezeichnung  
Désignation

Reference  
Teil Nummer  
Référence

L [mm]

l [mm]

h [mm]

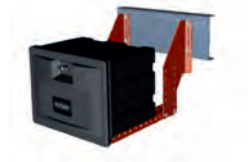

**Tool box support kit**  
*Halter Werkzeugkasten*  
Kit support de coffre à outils



M9000498

-

-

-

19

M62010099

520

480

500

7



**Plastic toolbox**  
*Plastik Werkzeugkasten*  
Coffre à outils plastique

M62010176

650

480

500

8

M62010696

800

480

500

10

M62010177

1000

480

500

12



**Black steel toolbox**  
*Schwarzer Stahlwerkzeugkasten*  
Coffre à outils acier noir

M62010815

600

400

500

22

M62010813

800

500

500

31

M62010814

1000

500

500

36

# NETBOX

## NETZBOX

### PANIER À FILET

#### NETBOX / Netzbox / Panier à filet

Designation Bezeichnung Désignation	Reference Teil Nummer Référence	L [mm]	l [mm]	h [mm]	Netbox support quantity needed Menge an Netzboxhaltern erforderlich Quantité de supports nécessaire	kg
 <p><b>Netbox</b> Netzbox Panier à filet réglable</p>	M9000497	750	480	180	2	16
		900	480	180	2	
		1050	480	180	3	
		1200	480	180	3	

Net box support to order separately Netzboxhalter separat zu bestellen Support panier à filet à commander séparément	Unit type Gerätetyp Type d'équipement	Reference Teil Nummer Référence	kg
--	---	---------------------------------------	----



T 13-15-26-30  
P 14-24  
S 14-21

M5331981\_80036

3

HT 18-24  
HP 17-20  
HC 21

M5337503\_80036

3



HT 26-30

M5340743\_80036

3,2

HT 07S-08

M5341402\_80036

2,4

#### DEEP NETBOX / Tiefe Netzbox / Panier à filet profond

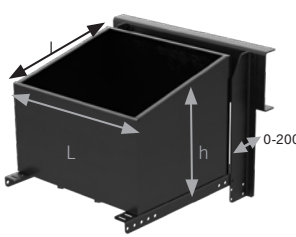
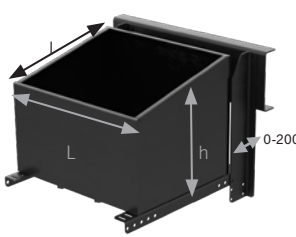
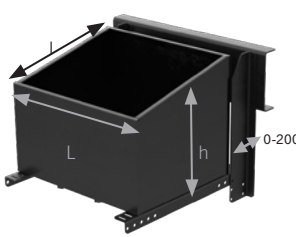
Designation Bezeichnung Désignation	Reference Teil Nummer Référence	L [mm]	l [mm]	h [mm]	kg
<p>RAL 9005</p>  <p><b>Small deep net box kit with support</b> Klein tiefe Netzkasten mit Halter Kit petit panier à filet profond avec support</p>	<p>M9001411</p> <p><b>NEW!</b></p>	650	650	600-450	48
 <p><b>Middle size deep net box kit with support</b> Mittlere tiefe Netzkasten mit Halter Kit moyen panier à filet profond avec support</p>	<p>M9001412</p> <p><b>NEW!</b></p>	800	650	600-450	52
 <p><b>Large deep net box kit with support</b> Breit tiefe Netzkasten mit Halter Kit grand panier à filet profond avec support</p>	<p>M9001413</p> <p><b>NEW!</b></p>	1000	650	600-450	58

General accessories  
Allgemeines Zubehör  
Accessoires généraux

Hookloader  
Abrollkipper  
Polybenne

Skip loader  
Absetzkipper  
Multibenne

Retrofit kits  
Nachrüstungssätze  
Kits rétrofit

# SCREWS AND NUTS

## SCHRAUBEN UND MUTTERN

### VIS ET ÉCROUS

#### Use Medium thread locker

Verwenden Sie Medium Thread Locker  
Utiliser du frein filet medium

**Not included** / Nicht enthalten / Non inclus



**For threads up to and including M36 or G1"**  
Für Gewinde bis einschließlich M36 oder G1 "  
Pour les filetages jusqu'à M36 ou G1 " inclus

## SCREWS

	Diameter Durchmesser Diamètre (mm)	Length Länge Longueur (mm)	Quality Qualität Qualité	Quantity per box Menge pro Box Quantité par boîte
M9000589	M10	40	10.9	25
M9000587	M12	40	10.9	25
M9001374	M14	30	10.9	25
M9000464	M14	40	10.9	50
M9000465	M14	50	10.9	50
M9001032	M14	80	10.9	25
M9001033	M14	100	10.9	25
M9000505	M16	50	10.9	50
M9000506	M16	60	10.9	50
M9001128	M16	80	10.9	25
M9001129	M16	100	10.9	25

## NUTS

	Diameter Durchmesser Diamètre (mm)	Quality Qualität Qualité	Quantity per box Menge pro Box Quantité par boîte
M9000597	M10	10.9	25
M9000588	M12	10.9	25
M9000463	M14	10.9	50
M9000507	M16	10.9	50

# VISION SOLUTION

## VISION LÖSUNG



### SOLUTION RÉTROVISION

CONFORM TO ECE R10

#### TOUCHSCREEN KIT / Touchscreen Rückkamera Bausatz / Kit écran tactile

View Sicht Vue	Designation Bezeichnung Désignation	Reference Teil Nummer Référence	Features Eigenschaften Caractéristiques
	<b>Palfinger Touchscreen kit</b> Palfinger Touchscreen Bausatz Kit écran tactile Palfinger	<b>M9001485</b> <b>NEW!</b>	<b>Ready to be connected to V Drive</b> <b>Touchscreen TFT 7" – Resolution 800x480 –</b> <b>Dimension 187x130x29 mm - Voltage 12/24 V</b> <b>Number of camera inputs: 4</b> <b>(3 shutter cameras max)</b> <b>Delivered with all needed harnesses and bracket in cab</b>  <i>Bereit zum Anschluss an V Drive</i> <i>7" TFT Schirm - Definition 800x480</i> <i>Abmessungen 187x130x29 mm - Spannung 12/24 V</i> <i>Eingänge Zahl für Kamera: 4</i> <i>(3 Kamera mit Klappen max)</i> <i>Geliefert mit geeignete Stecker und Halter im Fahrerhaus</i>  <i>Prêt à être connecté au V DRIVE</i> <i>Ecran tactile TFT 7" - définition 800x480 –</i> <i>Dimension 187x130x29 mm Voltage 12/24 V</i> <i>Nombre d'entrées caméra: 4</i> <i>(3 caméra avec obturateur max)</i> <i>Livré avec les connecteurs nécessaires et support en cabine</i>

#### CAMERA / Kamera / Caméra

	<b>Shutter camera</b> Kamera mit Klappen Caméra avec capot	<b>M65031438</b> <b>NEW!</b>	<b>Shutter, electro-mechanical driven</b> <b>HD 968x488 - IP69K</b> <b>Video format PAL</b> <b>Operating temperature -30° to +70°C Integrated heater</b> <b>Viewing angle 92°H 69°V</b>
	<b>Camera</b> Kamera Caméra	<b>M65031460</b> <b>NEW!</b>	<b>HD 968x488 - IP69K</b> <b>Video format PAL</b> <b>Operating temperature -20° to +70°C</b> <b>Viewing angle 115°</b>
	<b>Camera extension cable 15 m</b> Kamera Verlängerungskabel 15 m Câble d'extension caméra 15 m	<b>M4701236</b>	<b>GX12 connector</b>

#### REAR VISION KIT / Rückkamera Bausatz / Kit Retrovision

	<b>Complete rear vision kit</b> Komplett Rückkamera Bausatz Kit rétrovision complet	<b>M9001198</b>	<b>7" screen definition 1024x600 -</b> <b>Dimension 180x121x24 mm</b> <b>Voltage 12/24V</b> <b>Number of camera inputs: 4</b> <b>Screen sharing function 1-2 or 4 cameras</b> <b>Delivered with 1 remote control,</b> <b>1 camera &amp; extension cable</b>  <i>7" Schirm Definition 1024x600 -</i> <i>Abmessungen 180x121x24mm - Spannung 12/24V</i> <i>Eingänge Zahl für Kamera: 4</i> <i>Schirm Verteilung Funktion 1-2 oder 4 Kameras</i> <i>Geliefert mit ein Fernsteuerung, 1 Kamera und Verlängerungs-</i> <i>kabel</i>  <i>Ecran 7" définition 1024x600 -</i> <i>Dimension 180x121x24mm</i> <i>Voltage 12/24V</i> <i>Nombre d'entrées caméra: 4</i> <i>Fonction partage écran 1-2 ou 4 caméras</i> <i>Livré avec télécommande, une camera et cable d'extension</i>
--	---	-----------------	--

General accessories  
Allgemeines Zubehör  
Accessoires généraux

Hookloader  
Abrollkipper  
Polybenne

Skip loader  
Absetzkipper  
Multibenne



Retrofit kits  
Nachrüstungssätze  
Kits rétrofit

# VISION SOLUTION

## VISION LÖSUNG



### SOLUTION RETROVISION

#### WORKING LIGHTS / Arbeitsscheinwerfer / Phare de travail

	Designation Bezeichnung Désignation	Reference Teil Nummer Référence	kg
	<b>Working light LED 1210 Lumens</b> <i>Arbeitsscheinwerfer LED 1210 Lumens</i> Phare de travail à LED 1210 Lumens	M65031193	0,65
	<b>Working light 24 V ADR 1500 Lumens</b> <i>Arbeitsscheinwerfer 24 V ADR 1500 Lumens</i> Phare de travail 24 V ADR 1500 Lumens	M65031220	0,62
	<b>Worklight and camera support</b> <i>Arbeitsscheinwerfer und Kamera Halter</i> Support phare de travail et caméra	M5332091_80061	2,4



#### SILENT MODE / Leise Modus / Mode silencieux

	Designation Bezeichnung Désignation	Reference Teil Nummer Référence
	<b>Silent mode kit (middle position control box)</b> <i>Leise Modus Bausatz (Steuerblock in mittel Position)</i> Kit mode silencieux (Boitier distributeur milieu)	M9001373
	<b>Silent mode kit (vertical position control box)</b> <i>Leise Modus Bausatz (Steuerblock in vertikale Position)</i> Kit mode silencieux (Boitier distributeur vertical)	M9001372

Also available as ex-factory / Verfügbar als ab Werk / Egalement disponible sortie d'usine : **option 8201**



# PALFINGER MARKING – SPEED LIMIT

## PALFINGER BESCHILDERUNG – SPEEDSCHILD

### MARQUAGE PALFINGER – DISQUE DE VITESSE

CONFORM TO R104

#### PALFINGER REFLECTIVE TAPES / Reflexstreifen / Bandes réfléchissantes

	Designation Bezeichnung Désignation	Reference Teil Nummer Référence	 [m]
	<b>Reflective tape YELLOW</b> <i>Reflexstreifen GELB</i> Bande réfléchissante JAUNE	M62010722	50
	<b>Reflective tape RED</b> <i>Reflexstreifen ROT</i> Bande réfléchissante ROUGE	M62010724	50
	<b>Reflective tape WHITE</b> <i>Reflexstreifen WEISS</i> Bande réfléchissante BLANCHE	M62010725	50

PALFINGER branded  
PALFINGER markiert  
Marquage PALFINGER

CONFORM TO TPESC B 14038

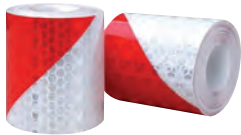

**Alternating Reflective tape left & right RED/WHITE**  
*Abwechselndes Reflexstreifen links & rechts ROT/WEISS*  
 Bande réfléchissante alternée gauche et droite BLANC/ROUGE

M62010697 10

#### PALFINGER REFLECTIVE TAPES / Reflexstreifen / Bandes réfléchissantes



**Speed limit disc 80 km/h**  
*Geschwindigkeitsschild 80 km/h*  
 Disque limitation de vitesse 80 km/h

M62010088



**Speed limit disc 90 km/h**  
*Geschwindigkeitsschild 90 km/h*  
 Disque limitation de vitesse 90 km/h

M62010089



**Speed limit discs support**  
*Geschwindigkeitshalter*  
 Support disques de vitesse

M9001349

General accessories  
Allgemeines Zubehör  
Accessoires généraux

Hookloader  
Abrollkipper  
Polybenne

Skiploader  
Absetzkipper  
Multibenne



Retrofit kits  
Nachrüstungssätze  
Kits rétrofit

# PALFINGER MARKING – SPEED LIMIT

## PALFINGER BESCHILDERUNG – SPEEDSCHILD













### MARQUAGE PALFINGER – DISQUE DE VITESSE

#### TOOLS SUPPORT / Werkzeuge Halter / Support outils

	Designation Bezeichnung Désignation	Reference Teil Nummer Référence
	<b>Tool support (2 brackets with screws)</b> <i>Werkzeughalter mit Schrauben</i> Support outils avec visserie	 <b>M9001334</b>

#### SIDE LIGHT SUPPORTS / Halter seitliche Leuchten / Supports de feux latéraux



	Designation Bezeichnung Désignation	Reference Teil Nummer Référence
 	<b>Side light support SCANIA/VOLVO</b> <i>Halter seitliche Leuchten SCANIA/VOLVO</i> Support feu latéral SCANIA/VOLVO	 <b>M5319590_80036</b>
 	<b>Side light support MAN</b> <i>Halter seitliche Leuchten MAN</i> Support feu latéral MAN	 <b>M5329924_80036</b>
 	<b>Side light support RENAULT/MERCEDES</b> <i>Halter seitliche Leuchten RENAULT/MERCEDES</i> Support feu latéral RENAULT/MERCEDES	 <b>M5317314_80036</b>
 	<b>Side light support DAF</b> <i>Halter seitliche Leuchten DAF</i> Support feu latéral DAF	 <b>M5329925_80036</b>

# HOOKLOADER INSTALLATION

## ABROLLKIPPER AUFBAU INSTALLATION BRAS



General accessories  
Allgemeines Zubehör  
Accessoires généraux

Hookloader  
Abrollkipper  
Polybenne

Skiploader  
Absetzkipper  
Multibenne

Retrofit kits  
Nachrüstungssätze  
Kits rétrofit

# BACK CAB PLATFORM

FRONTBRÜCKE

PASSERELLE DOS CABINE



M9000823

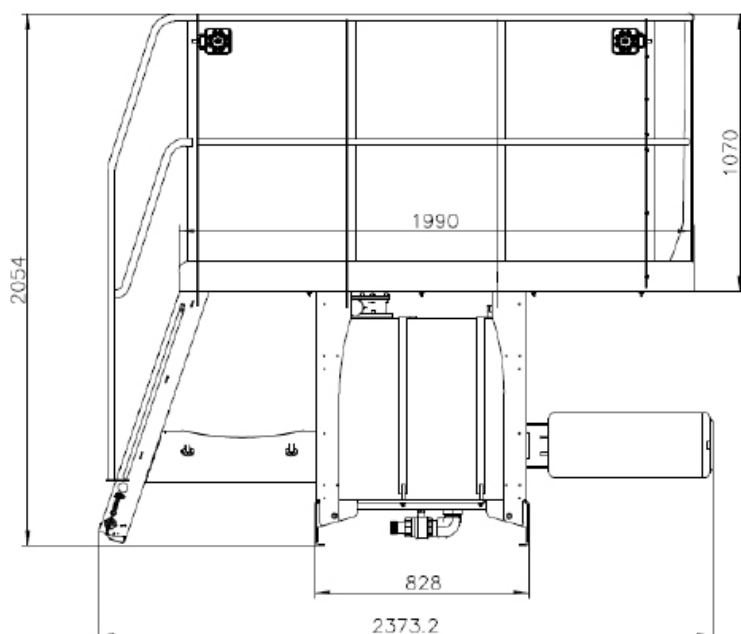

## INCLUDED / Inhalt / Inclus

- **Tank 120 L & set of coupling**  
*Tank 120 L & Verschraubungen*  
Réservoir 120 L & Raccords d'aspiration
- **2 LED working light wired**  
*2 LED Arbeitsscheinwerfer (gekabelt)*  
2 phares à LED cablés
- **Secured extendable ladder**  
*Gesicherte einziehbare Leiter*  
Echelle rétractable sécurisée
- **Plastic extinguisher box**  
*Feuerlöscherkasten*  
Coffre à extincteur

Conform EN ISO 14122-3

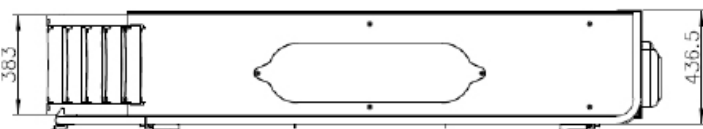

Designation  
Bezeichnung  
Désignation

Reference  
Referenz  
Référence



Back cab platform  
*Fhs Rückwand Frontbrücke*  
Passerelle dos cabine







M9000823

235

# TARP SYSTEM PALCOVER H

## PLANENSYSTEME PALCOVER H

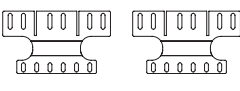
## SYSTÈME DE BÂCHAGE PALCOVER H

	Designation Bezeichnung Désignation	Reference Referenz Référence	kg
<b>PALCOVER H-E</b> 	<b>PALCOVER H-E with tarp - net with flaps</b> <i>PALCOVER H-E mit Plane - Netz mit Laschen</i> PALCOVER H-E bâche filet avec rabats	M9000780	230
	<b>PALCOVER H-E with tarp - net without flaps</b> <i>PALCOVER H-E mit Plane - Netz ohne Laschen</i> PALCOVER H-E bâche filet sans rabats	M9000783	220
	<b>PALCOVER H-E without tarp</b> <i>PALCOVER H-E ohne Plane</i> PALCOVER H-E sans bâche	M9000785	205
<b>PALCOVER H-M</b> 	<b>PALCOVER H-M with tarp - net with flaps</b> <i>PALCOVER H-M mit Plane - Netz mit Laschen</i> PALCOVER H-M bâche filet avec rabats	M9000767	220
	<b>PALCOVER H-M with tarp - net without flaps</b> <i>PALCOVER H-M mit Plane - Netz ohne Laschen</i> PALCOVER H-M bâche filet sans rabats	M9000782	220
<b>PALCOVER H-E fix</b> 	<b>PALCOVER H-E fix with tarp - net with flaps</b> <i>PALCOVER H-E fix mit Plane - Netz mit Laschen</i> PALCOVER H-E fixe bâche filet avec rabats	M9000790	30
	<b>Kit back cab. Tank 120 L + support for Palcover</b> <i>Fhs Rückwand Tank 120 L + Halter für Palcover</i> Kit réservoir 120 L + support pour Palcover <b>Narrow 120 L tank included</b>	M9001154	65
	<b>Palcover height increasing spacer (+ 200mm)</b> <i>Palcover Erhöhungsträger (+ 200mm)</i> Rehausse Palcover (+ 200mm) To be ordered by 2	M5335062_80036	4
	<b>Palcover safety</b> <i>Palcover Sicherheit</i> Sécurité stockage palcover Usefull to secure the hookloader operation	M9000881	1



Single parts Einzelteile Pièces détachées	Designation Bezeichnung Désignation	Reference Referenz Référence	kg
	<b>RRC for PALCOVER H-E / S-E / SA-T</b> <i>FFS für PALCOVER H-E / S-E / SA-T</i> Radio commande pour PALCOVER H-E / S-E / SA-T	M65031117	-
	<b>Tarp - net with flaps</b> <i>Plane - Netz mit Laschen</i> Bâche filet avec rabats	M2391004	15
	<b>Tarp - net without flaps</b> <i>Plane - Netz ohne Laschen</i> Bâche filet sans rabats	M2391009	12

General accessories  
Allgemeines Zubehör  
Accessoires généraux

Hookloader  
Abrollkipper  
Polybenne

Skiploader  
Absetzkipper  
Multibenne

Retrofit kits  
Nachrüstungssätze  
Kits rétrofit

# CAB CONTROL KIT

## KABINENSTEUERUNGSSATZ

### KIT COMMANDE CABINE

#### V DRIVE SUPPORT / V Drive Halterung / Support V Drive



**NEW!**

Designation <i>Bezeichnung</i> Désignation	Reference <i>Teil Nummer</i> Référence	Views <i>Aussicht</i> Vues
<b>Ground TEC cabin control support</b> <i>Halter 1- TEC Kabinensteuerung</i> Support commande cabine TEC au sol	M2157002	
<b>Multi-axis TEC cabin control support</b> <i>Multi-Axis TEC Kabinensteuerung</i> Support multi- axes pour commande cabine TEC	M2157003	
<b>Handrail TEC cabin control support</b> <i>Handrohr Halter - TEC Kabinensteuerung</i> Support commande cabine TEC pour main courante	M2157001	

#### EXTENSION CAB CONTROL / Erweiterungskabinensteuerung / Câble extension cde cabine

Designation <i>Bezeichnung</i> Désignation	Reference <i>Teil Nummer</i> Référence	Views <i>Aussicht</i> Vues
--	--	----------------------------------

**SPIRAL CABLE M12 M-F 5 WIRES**  
*SPIRALKABEL M12 M-F 5 KABEL*  
 Câble spiralé M12 M-F 5 fils

M65031020



# CONTAINER SUPPORT

## CONTAINER AUFLAGER

### SELLETTES



 **Single sold. Order by two / Einzel verkauft. Zu zwei bestellen / Vendue à l'unité. A commander par 2.**

## ANTIFRICTION CONTAINER SUPPORT / Antifriction Container-Auflager / Sellettes antifriction



Unit type Gerätetyp Type d'équipement	Finish Beschichtung Finition	Reference Teil Nummer Référence
HT 18-24 PH T 18-24	RAL 9005	M2065781_R9005
HT 26-30	RAL 9005	M2065801_R9005
HT 18-24 A ACTS PH T 18-24 A ACTS	RAL 9005	M2065786_R9005
HT 26 A ACTS	RAL 9005	M2065813_R9005
HT 20-22 CHEM PH T 20-22 CHEM	RAL 9005	M2065800_R9005
HT 22 A DINO PH T 22 A DINO	RAL 9005	M2065791_R9005

## BOLTED CONTAINER SUPPORT / Container-Auflager geschraubt / Sellettes boulonnées



Unit type Gerätetyp Type d'équipement	Finish Beschichtung Finition	Reference Teil Nummer Référence
HT 18-24 PH T 18-24 HP 17-20	RAL 9005	M2065794_R9005
HT 26-30 HP 24	RAL 9005	M2065805_R9005
HT 18-24 A ACTS PH T 18-24 A ACTS	RAL 9005	M2065795_R9005
HT 26 A ACTS	RAL 9005	M2065815_R9005
HT 20-22 CHEM PH T 20-22 CHEM	RAL 9005	M2065799_R9005
HT 22 A DINO PH T 22 A DINO	RAL 9005	M2065790_R9005

General accessories  
Allgemeines Zubehör  
Accessoires généraux

Hookloader  
Abrollkipper  
Polybenne

Skiploader  
Absetzkipper  
Multibenne

Retrofit kits  
Nachrüstungssätze  
Kits rétrofit

# SAM ADVANTAGES

## SAM VORTEILE AVANTAGES SAM

HT 18-20 / HP 17-20 / HC 21



6x2 6x4 26 t

M9100046  
SAM Advantage 26 t



6x2 6x4 26 t

M9100047  
SAM Advantage Back cab

Designation Bezeichnung Désignation	Quantity Menge Quantité	Reference Teil Nummer Référence	Quantity Menge Quantité	Reference Teil Nummer Référence
<b>Tank kit</b> Bausatz Tank Kit réservoir	1	M2371863 130 l	1	M2372021 vertical / vertikal / vertical 120 l + support Halter / support
<b>Tank support kit</b> Halter für Hydrauliktank Kit support réservoir	1	M9000482	1	
<b>Pump kit LEDUC</b> Bausatz Pumpe LEDUC Kit pompe LEDUC	1	M2371310 XPI 80	1	M2371310 XPI 80
<b>LED working light 1210 Lumens</b> Arbeitscheinwerfer LED 1210 Lumens Phare de travail à LED 1210 Lumens	1	M65031193	1	M65031193
<b>Working light support kit</b> Halter für Arbeitsscheinwerfer Kit support phare de travail	1	M5332091_80061 vertical	1	M5331980_80061 for back cab extinguisher für vertikal Feuerlöscher pour extincteur dos cabine
<b>Kit 4 supports + 4 aluminium profiles 3,5 m</b> Bausatz 4 Halter + 4 Aluminium Profile 3,5 m Pare Cyclistes Kit 4 supp + 4 barres 3,5 m	1	M9000400	1	M9000400
<b>2 axes alu mudguards kit + reflecting tape support</b> 2 Achsen Alu-Kotflügel Bausatz + Halterung für reflektiv Aufkleber Kit ailes alu double essieux + support bande réfléchissante	1	M9001355	1	M9001355
<b>Rear Light support kit</b> Bausatz Halter Rückleuchten Kit support feux arrière	1	M9000481	1	M9000481
<b>Netbox</b> Netzkasten Panier à filet	1	M9000497	1	M9000497
<b>Netbox support</b> Netzboxhalter Support panier à filet	2	M5337503_80036	2	M5337503_80036
<b>Plastic toolbox 650x500x480</b> Plastik Werkzeugkasten 650x500x480 Coffre à outils plastique 650x500x480	1	M62010176	1	M62010176
<b>Toolbox support kit</b> Halter Werkzeugkasten Kit support coffre à outils	1	M9000498	1	M9000498
<b>Plastic extinguisher box</b> Feuerlöscherkasten Coffre extincteur plastique	1	M66000107 horizontal	1	M66000041 vertical
<b>Support kit for extinguisher</b> Halter Bausatz für Feuerlöscher Kit support extincteur	1	M5340150_80030 horizontal	1	M5339887_80030 vertical

# SUBFRAME EXTENSION

## UNTERRAHMENVERLÄNGERUNG

### RALLONGE FAUX CHÂSSIS

**SUBFRAME EXTENSION > 5 t / Unterrahmenverlängerung > 5 t / Rallonge faux chassis > 5 t**

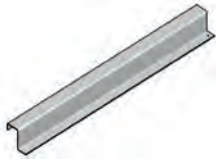

L = 2 m

primer  
grundiert  
en apprêt

Designation Bezeichnung Désignation	Reference Teil Nummer Référence	Unit type Gerätetyp Type d'équipement	Thickness [mm] Dicke Épaisseur	kg
Subframe extension Unterrahmenverlängerung Rallonge Faux Châssis	M5328662	T 07	5	20
	M5339738	HT 07S - HT 08	5	22
	M5328677	T13 - T15 - P14 - S14 - PH T 17 SCAN	6	38
	M5328665	T18 - P17 - S17 - T20 (L ≤ 6000)	6	40
	M5328666	T20 (L ≥ 6150) - T22 - T24 - P20 - S21	8	52
	M5328667	T/HT 26-30 - P/HP 24	8	56
	M5328678	PH T 20-22-24 SCAN	8	49
	M5337848	PH T/HT 18-20 - HP 17	6	39
	M5337849	PH T/HT 18-20-22-24 - HP 20 - HC 21	8	51

**SUBFRAME EXTENSION KIT FOR HT 05 / Bausatz Unterrahmenverlängerung HT 05 / Kit rallonge faux chassis HT 05**

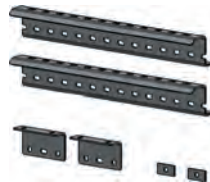
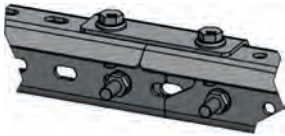

L = 1 m

RAL 7021

Designation Bezeichnung Désignation	Reference Teil Nummer Référence	Thickness [mm] Dicke Épaisseur	kg
Subframe extension kit Bausatz Unterrahmenverlängerung Kit Rallonge Faux Châssis	M9000834	5	20

**SUBFRAME EXTENSION KIT FOR CITY / Bausatz Unterrahmenverlängerung CITY / Kit rallonge faux chassis CITY**

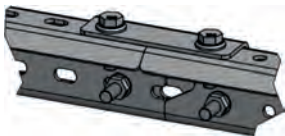

L = 650 mm

RAL 7021

Designation Bezeichnung Désignation	Reference Teil Nummer Référence	Thickness [mm] Dicke Épaisseur	kg
Subframe extension kit Bausatz Unterrahmenverlängerung Kit Rallonge Faux Châssis	M9000659	4	9

General accessories  
Allgemeines Zubehör  
Accessoires généraux

Hookloader  
Abrollkipper  
Polybenne

Skiploader  
Absetzkipper  
Multibenne

Retrofit kits  
Nachrüstungssätze  
Kits rétrofit

# STABILIZER

## ABSTÜTZUNG

## STABILISATEUR

### AXLE STABILIZER / Achsabstützung / Blocage essieu

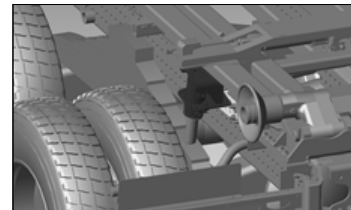
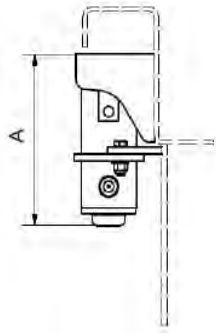
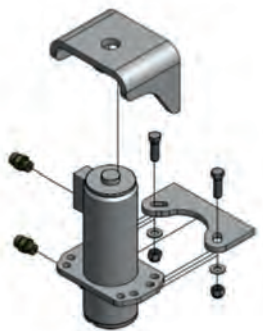

Designation Bezeichnung Désignation	Reference Teil Nummer Référence	A mini [mm] A mini Tige rentrée	A maxi [mm] A maxi Tige sortie	kg
<b>Short axle stabilizer kit</b> Bausatz Achsabstützung kurz Kit blocage essieux court	<b>M2371437</b>	237	360	23,6
<b>Long axle stabilizer kit</b> Bausatz Achsabstützung lang Kit blocage essieu long	<b>M2371445</b>	287	460	25,6
<b>Cylinder rod tip</b> Plattfederschutz für Achsabstützung Embout de tige	<b>M5116221</b>	for Mercedes truck - sold by two für Mercedes-Fahrgestell - Verkauf im Zweierpack pour Châssis Mercedes - Vente par 2		

Hookloader option code required / Option für Abrollkipper erforderlich / Option nécessaire sur le bras: **4401/4402/4403**

### ROLLER STABILIZER / Rollenabstützung / Rouleau anti-cabrage

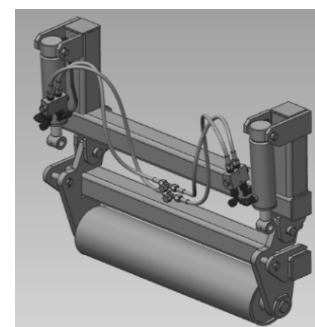
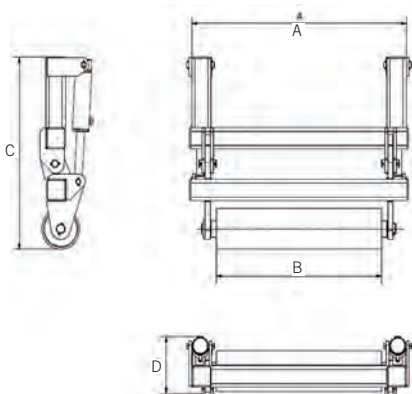

Designation Bezeichnung Désignation	Reference Teil Nummer Référence	For unit Gerätetyp Pour bras	A [mm]	B [mm]	C [mm]	D [mm]	kg
<b>Rear roller stabilizer</b> Bausatz Rollenabstützung Rouleau anti-cabrage	<b>M2371438</b>	≥ 13 t	900	410	846	256	90
	<b>M2085021</b>	(1150 mm) ≥ 13 t	1460	1150	916	268	215
	<b>M2085023</b>	(850 mm) ≥ 13 t	1160	850	916	268	185

Hookloader option code required / Option für Abrollkipper erforderlich / Option nécessaire sur le bras: **4400**

# INTERFACE HOOKLOADER/CRANE

## VORBEREITUNG - KRANMONTAGE

### INTERFACE BRAS / GRUE

#### PK TEC CRANE / PK TEC Kran / Grue PK TEC

#### KIT SELECTION

- 1: Order the unit with the option 9316 « TEC crane interface »
- 2: Select the TEC crane mounting kit in the table below according to the hookloader model and truck.
- 3: Select the hookloader mounting kit and bolts kits according to the hookloader & truck model in the Mounting kits chapter.

#### BAUSATZ AUSWAHL

- 1: Bestellen Sie das Gerät mit der Option 9316 «TEC Kranschnittstelle»
- 2: Wählen Sie das Montageset für den TEC-Kran entsprechend dem Abrollkippermodell und LKW in der Tabelle unten.
- 3: Wählen Sie das Montageset für den Abrollkipper und die Schraubensätze entsprechend dem Abrollkipper- und LKW-Modell in dem Montagebausätze Kapitel.

#### SELECTION DES KITS

- 1: Commander le bras avec l'option 9316 « Interface grue TEC »
- 2: Sélectionner le kit de montage de la grue TEC dans le tableau ci-dessous, selon le bras et le camion.
- 3: Sélectionner le kit de montage pour le bras et le kit de boulons selon le bras et le camion dans le chapitre Kits de montage.

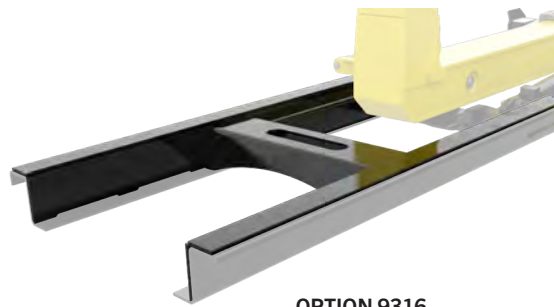

OPTION 9316

#### TEC CRANE MOUNTING KIT / TEC Kran Montageset / Kit montage grue TEC

Unit type Gerätetyp Type d'équipement	VOLVO RENAULT TRUCKS	SCANIA	MAN	MERCEDES Mercedes-Benz	UNIVERSAL * IVECO DAF
HT 18-24 HP 17-20 S 21	M9001424	M9001392	M9001386	M9001380	M9001399
HT 26-30 HP 24	M9001378	M9001394	M9001388	M9001382	M9001400
PH T 17-24 SCAN T 13-15 P 14	M9001379	M9001396	M9001390	M9001384	M9001401

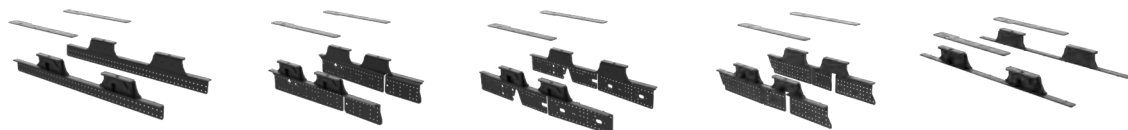

\* The universal mounting kit consists of the required top mounting parts. The bottom fixation is not included as the truck specification is not defined.

\* Der Universal-Montagesatz besteht aus den erforderlichen oberen Befestigungsteilen. Die untere Befestigung ist nicht im Lieferumfang enthalten, da die LKW-Spezifikation nicht definiert ist.

\* Le kit de montage universel comprend les pièces de montage nécessaires en partie supérieure. La fixation inférieure n'est pas incluse car la spécification du camion n'est pas définie.

# INTERFACE HOOKLOADER/CRANE

## VORBEREITUNG - KRANMONTAGE

### INTERFACE BRAS / GRUE

#### PK SLD-SH-EH CRANE / PK SLD-SH-EH Kran / Grue PK SLD-SH-EH

##### KIT SELECTION

1: Order the unit with the option 9314 « Epsilon crane interface » or 9315 « PK SLD/EH/SH crane interface »

Then 2 possibilities:

2: In the Mounting kit chapter select directly the kit identified with the icon combo crane hookloader. Complete your basket with the mounting bolts kit selection.



Or

2: In the table below, select the crane mounting kit according the hookloader model and truck.

3: In the Mounting kit chapter select the hookloader mounting kit and bolts kits according to the hookloader & truck model.

##### BAUSATZ AUSWAHL

1: Bestellen Sie das Gerät mit der Option 9314 «Epsilon Kranschnittstelle» oder 9315 „PK SLD/EH/SH Kranschnittstelle“

Danach 2 Möglichkeiten:

2: Im Montage Bausatz Kapitel, wählen Sie das Combo Kran Abrollkipper Montageset gekennzeichnet mit Icon Combo Kran Abrollkipper. Ergänzen Sie der Warenkorb mit dem Schraubensatz.



Oder

2: Wählen Sie das Montageset für den Kran entsprechend dem Abrollkippermodell und LKW nach der Tabelle unten.

3: Im Montage Bausatz Kapitel, wählen Sie das Abrollkipper Montageset und Schraubensatz .

##### SELECTION DES KITS

1: Commander le bras avec l'option 9314 « Interface grue Epsilon TEC » ou 9315 « Interface grue PK SLD/EH/SH »

Ensuite 2 possibilités:

2: Aller dans la section Kit de montage et sélectionner directement le kit identifié par l'icône combinaison bras grue. Compléter votre panier avec le kit de boulons de montage



Ou

2: Dans le tableau ci-dessous, sélectionner le kit de montage de la grue selon le bras et le camion.

3: Dans le chapitre Kit de montage, sélectionner le kit de montage pour le bras et le kit de boulons selon le bras et le camion.

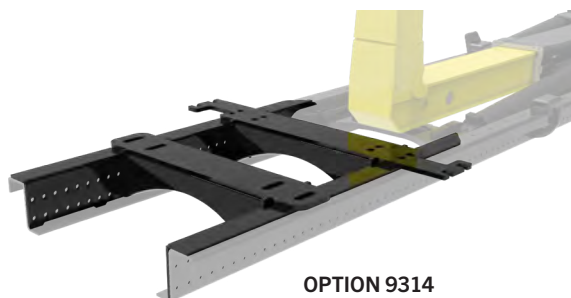

OPTION 9314

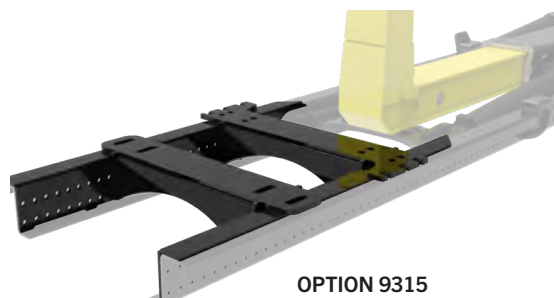

OPTION 9315

#### SLD-SH-EH CRANE MOUNTING KIT / SLD-SH-EH Kran Montageset / Kit montage grue SLD-SH-EH

Unit type Gerätetyp Type d'équipement	VOLVO RENAULT TRUCKS	MAN	MERCEDES AIR SUSPENSION	UNIVERSAL * IVECO DAF
HT 18-30 HP 17-24 HC 21	M9000730	M9000849	M9000728	M9000729
T 13-30 P 14-24 S 14-21	M9000730	M9000779	M9000728	M9000729
PH T 17-24 SCAN	M9000730	M9000781	M9000728	M9000729

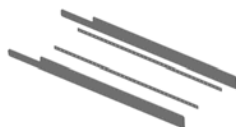

\* The universal mounting kit consists of the required top mounting parts. The bottom fixation is not included as the truck specification is not defined.

\* Der Universal-Montagesatz besteht aus den erforderlichen oberen Befestigungsteilen. Die untere Befestigung ist nicht im Lieferumfang enthalten, da die LKW-Spezifikation nicht definiert ist.

\* Le kit de montage universel comprend les pièces de montage nécessaires en partie supérieure. La fixation inférieure n'est pas incluse car la spécification du camion n'est pas définie.

# HEAVY RANGE MOUNTING KIT 13-30 T

SCHWERE REIHE  
MONTAGE BAUSATZ 13-30 T  
GAMME LOURDE  
KIT DE FIXATION 13-30 T



General accessories  
Allgemeines Zubehör  
Accessoires généraux

Hookloader  
Abrollkipper  
Polybenne

Skiploader  
Absetzkipper  
Multibenne

Retrofit kits  
Nachrüstungssätze  
Kits rétrofit

# HEAVY RANGE MOUNTING KIT 13-30 T

## SCHWERE REIHE MONTAGE BAUSATZ 13-30 T

### GAMME LOURDE KIT DE FIXATION 13-30 T

#### RENAULT T-K-C / VOLVO FMX-FH-FM

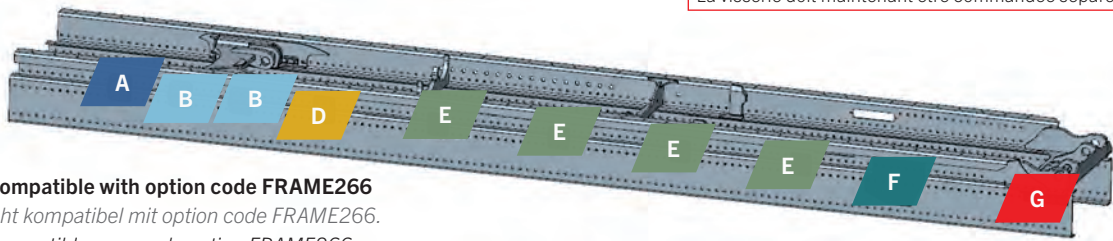

**Bolts are now to be ordered separately**  
*Schrauben sind jetzt separat zu bestellen*  
*La visserie doit maintenant être commandée séparément*

**Incompatible with option code FRAME266**  
*Nicht kompatibel mit option code FRAME266.*  
*Incompatible avec code option FRAME266.*

#### BOLTS - SCHRAUBEN - VISSERIE

		Length / Länge / Longueur (mm)				
		40	50	60	80	100
M9001462	Ø14	M9000464 x2 (qty 50/box)	M9000465 x2 (qty 50/box)	-	-	M9000463 x2 (qty 100/box)

#### TELESCOPIC HT 18-30 (A) - POWER HP 17-24 A - SYNCHRON HC 21

		CRANE	A	B	D	E	F	G
		INTERFACE PK SLD-EH-SH EPSILON			-			
M9001433		-	x1	x2	-	x6	-	x1
M9001011		x1	-	-	-	x6	-	x1
<b>Retailed kits</b> <i>Einzeln Bausätze</i> <i>Kits au détail</i>		M9000730	M9000886	M9001155	-	M9000887	M9000947 <sup>Ⓢ</sup> M9000462 <sup>Ⓢ</sup>	M9000991

#### TELESCOPIC T 13-30 (A) - POWER P 14-24 (A) - SYNCHRON S 14-21

		CRANE	A	B	D	E	F	G
		INTERFACE PK SLD-EH-SH EPSILON						
M9001434		-	x1	x2	x1	x5	-	x1
M9001170		x1	-	x1	x1	x5	-	x1
<b>Retailed kits</b> <i>Einzeln Bausätze</i> <i>Kits au détail</i>		M9000730	M9000886	M9000433	M9001138	M9000887	M9000888 <sup>Ⓢ</sup> M9000947 <sup>Ⓢ</sup> M9000462 <sup>Ⓢ</sup>	M9001132

Ⓢ 13->15 Ⓢ 18->24 Ⓢ 26->30 & P/HP 24

## MAN TGA - TGS - TGX

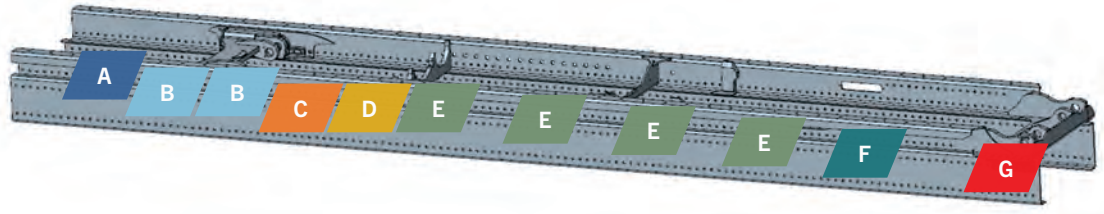

**Bolts are now to be ordered separately**  
*Schrauben sind jetzt separat zu bestellen*  
 La visserie doit maintenant être commandée séparément

## BOLTS - SCHRAUBEN - VISSERIE

		Length / Länge / Longueur (mm)					
		40	50	60	80	100	
M9001463	Ø14	M9000464 x1 (qty 50/box)	M9000465 x1 (qty 50/box)	-	M9001032 x1 (qty 25/box)	M9001033 x1 (qty 25/box)	M9000463 x2 (qty 100/box)

## TELESCOPIC HT 18-30 (A) - POWER HP 17-24 A - SYNCHRON HC 21

	CRANE	A	B	C	D	E	F	G	
	INTERFACE PK SLD-EH-SH EPSILON				-				
M9001436		-	x1	x2	x1	-	x5	-	x1
M9001455		x1	-	-	x1	-	x5	-	x1
<b>Retailed kits</b> <i>Einzeln Bausätze</i> Kits au détail	M9000849	M9000900	M9001156	M9001156	-	M9000901	M9000949	M9001034	

## TELESCOPIC T 13-30 (A) - POWER P 14-24 (A) - SYNCHRON S 14-21

	CRANE	A	B	C	D	E	F	G	
	INTERFACE PK SLD-EH-SH EPSILON								
M9001437		-	x1	x1	x1	x1	x4	-	x1
M9001171		x1	-	-	x1	x1	x4	-	x1
<b>Retailed kits</b> <i>Einzeln Bausätze</i> Kits au détail	M9000779	M9000900	M9000451	M9000450	M9001139	M9000901	M9000904 <sup>Ⓞ</sup> M9000949 <sup>Ⓞ</sup> M9000949 <sup>Ⓞ</sup>	M9001134	

Ⓞ 13->15 Ⓞ 18->24 Ⓞ 26->30 & P/HP 24

General accessories  
 Allgemeines Zubehör  
 Accessoires généraux

Hookloader  
 Abrollkipper  
 Polybenne

Skiploader  
 Absetzkipper  
 Multibenne

Retrofit kits  
 Nachrüstungssätze  
 Kits rétrofit

# HEAVY RANGE MOUNTING KIT 13-30 T

## SCHWERE REIHE MONTAGE BAUSATZ 13-30 T

### GAMME LOURDE KIT DE FIXATION 13-30 T

MERCEDES ACTROS NEW, ANTOS & AROCS - LEAF SUSPENSION / *Stahlfederung / Suspension mécanique*



Mercedes-Benz

**Bolts are now to be ordered separately**  
*Schrauben sind jetzt separat zu bestellen*  
 La visserie doit maintenant être commandée séparément

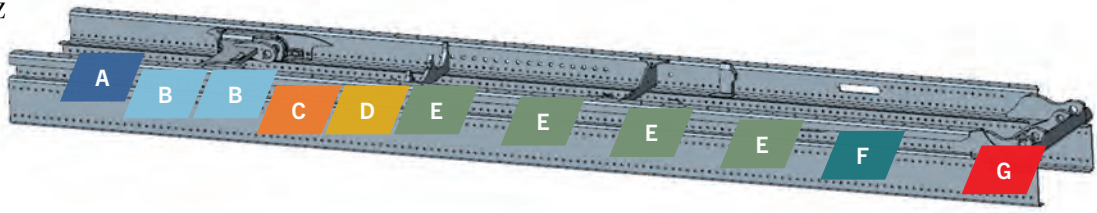

### BOLTS - SCHRAUBEN - VISSERIE

		Length / Länge / Longueur (mm)					
		40	50	60	80	100	
M9001464	$\varnothing 14$	M9000464 x1 (qty 50/box)	M9000465 x1 (qty 50/box)	-	M9001032 x1 (qty 25/box)	M9001033 x1 (qty 25/box)	M9000463 x1 (qty 100/box)
	$\varnothing 16$	-	M9000505 x1 (qty 50/box)	M9000506 x1 (qty 50/box)	M9001128 x1 (qty 25/box)	M9001129 x1 (qty 25/box)	M9000507 x1 (qty 100/box)

### TELESCOPIC HT 18-30 (A) - POWER HP 17-24 A - SYNCHRON HC 21

		CRANE	A	B	C	D	E	F	G
		INTERFACE PK SLD-EH-SH EPSILON				-			
M9001439	< 7200 mm	-	x1	x2	x1	-	x5	-	x1
M9001456		x1	-	-	x1	-	x5	-	x1
Retailed kits <i>Einzeln Bausätze</i> Kits au détail		M9000729	M9000909	M9001160	M9001161	-	M9001130	M9000950	M9000991

### TELESCOPIC T 13-30 (A) - POWER P 14-24 (A) - SYNCHRON S 14-21

		CRANE	A	B	C	D	E	F	G
		INTERFACE PK SLD-EH-SH EPSILON							
M9001440		-	x1	x1	x1	x1	x4	-	x1
M9001172		x1	-	-	x1	x1	x4	-	x1
Retailed kits <i>Einzeln Bausätze</i> Kits au détail		M9000729	M9000909	M9000647	M9000648	M9001140	M9001130	M9000913 <sup>Ⓞ</sup> M9000950 <sup>Ⓞ</sup> M9000950 <sup>Ⓞ</sup>	M9001133

Ⓞ 13->15 Ⓞ 18->24 Ⓞ 26->30 & P/HP 24

## MERCEDES ACTROS NEW, ANTOS & AROCS - AIR SUSPENSION / Luftfederung / Suspension pneumatique



Mercedes-Benz

**Bolts are now to be ordered separately**  
 Schrauben sind jetzt separat zu bestellen  
 La visserie doit maintenant être commandée séparément

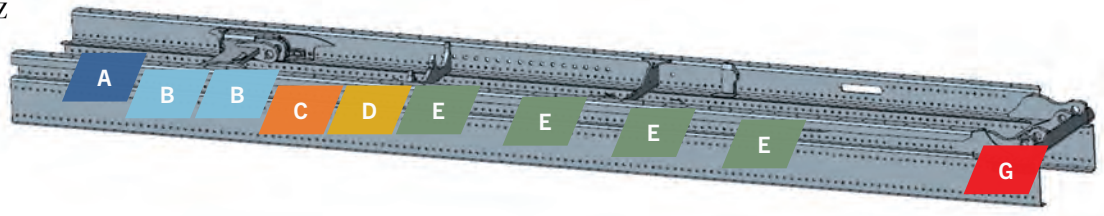

### BOLTS - SCHRAUBEN - VISSERIE

		Length / Länge / Longueur (mm)				
		40	50	60	80	100
M9001465	Ø14	M9000464 x1 (qty 50/box)	M9000465 x1 (qty 50/box)	-	-	M9000463 x1 (qty 100/box)
	Ø16	-	M9000505 x1 (qty 50/box)	M9000506 x1 (qty 50/box)	-	M9000507 x1 (qty 100/box)

### TELESCOPIC HT 18-30 (A) - POWER HP 17-24 A - SYNCHRON HC 21

		CRANE	A	B	C	D	E	G
		INTERFACE PK SLD-EH-SH EPSILON				-		
M9001441	< 7200 mm	-	x1	x2	x1	-	x5	x1
M9001019		x1	-	-	x1	-	x5	x1
<b>Retailed kits</b> Einzel Bausätze Kits au détail		M9000728	M9000909	M9001160	M9001161	-	M9000920	M9000991

### TELESCOPIC T 13-30 (A) - POWER P 14-24 (A) - SYNCHRON S 14-21

		CRANE	A	B	C	D	E	G
		INTERFACE PK SLD-EH-SH EPSILON						
M9001442		-	x1	x2	x1	x1	x4	x1
M9001173		x1	-	-	x1	x1	x4	x1
<b>Retailed kits</b> Einzel Bausätze Kits au détail		M9000728	M9000909	M9000647	M9000648	M9001141	M9000920	M9001132

# HEAVY RANGE MOUNTING KIT 13-30 T

## SCHWERE REIHE MONTAGE BAUSATZ 13-30 T

### GAMME LOURDE KIT DE FIXATION 13-30 T

IVECO S WAY - X WAY

IVECO

Bolts are now to be ordered separately  
 Schrauben sind jetzt separat zu bestellen  
 La visserie doit maintenant être commandée séparément

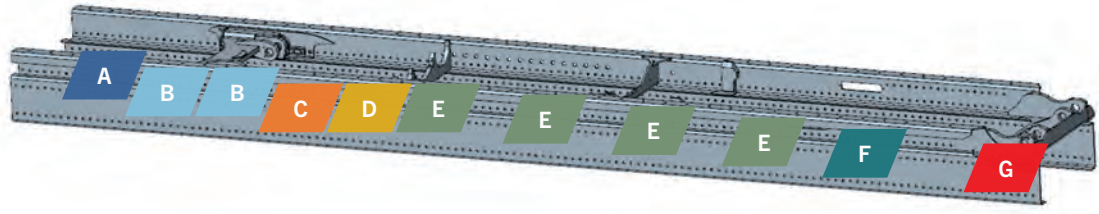

### BOLTS - SCHRAUBEN - VISSERIE

		Length / Länge / Longueur (mm)					
		40	50	60	80	100	
M9001463	Ø14	M9000464 x1 (qty 50/box)	M9000465 x1 (qty 50/box)	-	M9001032 x1 (qty 25/box)	M9001033 x1 (qty 25/box)	M9000463 x2 (qty 100/box)

### TELESCOPIC HT 18-30 (A) - POWER HP 17-24 A - SYNCHRON HC 21

		CRANE	A	B	C	D	E	F	G
		INTERFACE PK SLD-EH-SH EPSILON				-			
M9001447	 < 7200 mm	-	x1	x2	x1	-	x5	-	x1
M9001458		x1	-	x1	x1	-	x4	-	x1
Retailed kits Einzel Bausätze Kits au détail		M9000729	M9000935	M9001167	M9000740	-	M9001131	M9000952 <sup>Ⓞ</sup> M9000951 <sup>Ⓞ</sup>	M9000994

### TELESCOPIC T 13-30 (A) - POWER P 14-24 (A) - SYNCHRON S 14-21

		CRANE	A	B	C	D	E	F	G
		INTERFACE PK SLD-EH-SH EPSILON							
M9001448		-	x1	x2	x1	x1	x4	-	x1
M9001175		x1	-	x1	x1	x1	x3	-	x1
Retailed kits Einzel Bausätze Kits au détail		M9000729	M9000935	M9000739	M9000740	M9001142	M9001131	M9000938 <sup>Ⓞ</sup> M9000952 <sup>Ⓞ</sup> M9000951 <sup>Ⓞ</sup>	M9001338

Ⓞ 13->15 Ⓞ 18->24 Ⓞ 26->30 & P/HP 24

## SCANIA P - R - G



**Bolts are now to be ordered separately**  
*Schrauben sind jetzt separat zu bestellen*  
 La visserie doit maintenant être commandée séparément

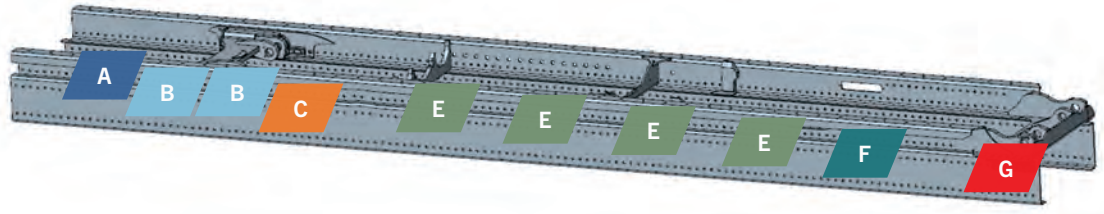

## BOLTS - SCHRAUBEN - VISSERIE

	Ø	Length / Länge / Longueur (mm)					
		40	50	60	80	100	
M9001463	Ø14	M9000464 x1 (qty 50/box)	M9000465 x1 (qty 50/box)	-	M9001032 x1 (qty 25/box)	M9001033 x1 (qty 25/box)	M9000463 x2 (qty 100/box)

## TELESCOPIC HT 18-30 (A) - POWER HP 17-24 A - SYNCHRON HC 21

	CRANE	A	B	C	E	F	G	
	INTERFACE PK SLD-EH-SH EPSILON							
M9001444		-	x1	x2	x1	x5	-	x1
M9001457		x1	-	x1	x1	x4	-	x1
<b>Retailed kits</b> <i>Einzeln Bausätze</i> Kits au détails	M9000729	M9000810 + M9000748	M9001165	M9001166	M9000928	M9000951	M9000991	

## TELESCOPIC T 13-30 (A) - POWER P 14-24 (A) - SYNCHRON S 14-21

	CRANE	A	B	C	E	F	G	
	INTERFACE PK SLD-EH-SH EPSILON							
M9001445		-	x1	x1	x1	x5	-	x1
M9001174		x1	-	x1	x1	x4	-	x1
<b>Retailed kits</b> <i>Einzeln Bausätze</i> Kits au détail	M9000729	M9000810 + M9000748	M9000853	M9000750	M9000928	M9000930 <sup>Ⓞ</sup> M9000951 <sup>Ⓞ</sup> M9000951 <sup>Ⓞ</sup>	M9001133	

# HEAVY RANGE MOUNTING KIT 13-30 T

## SCHWERE REIHE MONTAGE BAUSATZ 13-30 T

### GAMME LOURDE KIT DE FIXATION 13-30 T

DAF XD-XF-XG 6X4 / 8X2 / 8X4 - DAF XD-XF-XG 4X2 / 6X2 (← 2025/06)



Bolts are now to be ordered separately  
Schrauben sind jetzt separat zu bestellen  
La visserie doit maintenant être commandée séparément

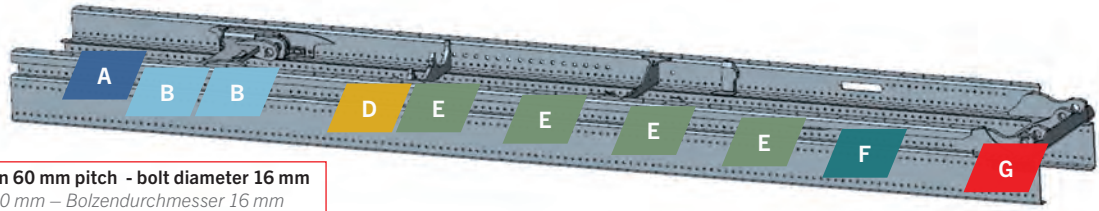

Chassis drilling pattern 60 mm pitch - bolt diameter 16 mm  
Chassis Lochabstand 60 mm – Bolzendurchmesser 16 mm  
Perçage châssis pas de 60 mm – Diamètre boulon 16 mm

### BOLTS - SCHRAUBEN - VISSERIE

		Length / Länge / Longueur (mm)					
		40	50	60	80	100	
M9001464	Ø14	M9000464 x1 (qty 50/box)	M9000465 x1 (qty 50/box)	-	-	-	M9000463 x1 (qty 100/box)
	Ø16	-	M9000505 x1 (qty 50/box)	M9000506 x1 (qty 50/box)	M9001128 x1 (qty 50/box)	M9001129 x1 (qty 50/box)	M9000507 x1 (qty 100/box)

### TELESCOPIC HT 18-30 (A) - POWER HP 17-24 A - SYNCHRON HC 21

		CRANE	A	B	D	E	F	G
		INTERFACE PK SLD-EH-SH EPSILON			-			
M9001493	< 7200 mm		x1	x2	-	x6	-	x1
M9001496		x1	-	x1	-	x5	-	x1
Retailed kits Einzel Bausätze Kits au détail		M9000729	M9000943	M9001169	-	M9001122	M9001010	M9001007

### TELESCOPIC T 13-30 (A) - POWER P 14-24 (A) - SYNCHRON S 14-21

		CRANE	A	B	D	E	F	G
		INTERFACE PK SLD-EH-SH EPSILON						
M9001494			x1	x1	x1	x4	-	x1
M9001497		x1	-	x1	x1	x4	-	x1
Retailed kits Einzel Bausätze Kits au détail		M9000729	M9000943	M9001499	M9001143	M9001122	M9001009 <sup>Ⓞ</sup> M9001010 <sup>Ⓞ</sup> M9001010 <sup>Ⓞ</sup>	M9001135

Ⓞ 13->15 Ⓞ 18->24 Ⓞ 26->30 & P/HP 24

**NEW!**

**DAF XD-XF-XG 4X2/6X2 (2025/06 →)**



**Bolts are now to be ordered separately**  
*Schrauben sind jetzt separat zu bestellen*  
*La visserie doit maintenant être commandée séparément*

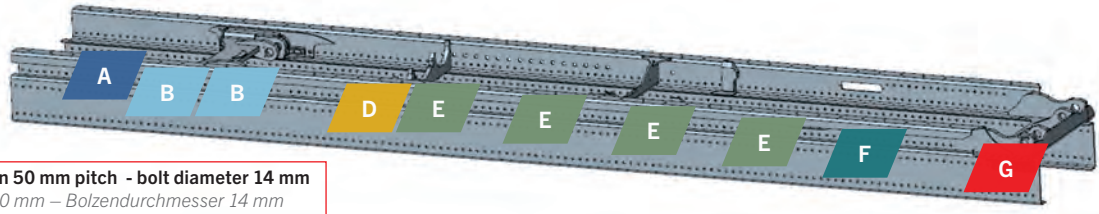

**Chassis drilling pattern 50 mm pitch - bolt diameter 14 mm**  
*Chassis Lochabstand 50 mm – Bolzendurchmesser 14 mm*  
*Perçage châssis pas de 50 mm – Diamètre boulon 14 mm*

**BOLTS - SCHRAUBEN - VISSERIE**

		Length / Länge / Longueur (mm)						
		40	50	60	80	100		

M9001463	Ø14	M9000464 x1 (qty 50/box)	M9000465 x1 (qty 50/box)	-	M9001032 x1 (qty 25/box)	M9001033 x1 (qty 25/box)	M9000463 x2 (qty 100/box)
----------	-----	-----------------------------	-----------------------------	---	-----------------------------	-----------------------------	------------------------------

**TELESCOPIC HT 18-30 (A) - POWER HP 17-24 A - SYNCHRON HC 21**

	CRANE	A	B	D	E	F	G	
	INTERFACE PK SLD-EH-SH EPSILON			-				
M9001449		x1	x2	-	x5	-	x1	
M9001459		x1	-	x1	-	x5	-	x1

**Retailed kits**  
*Einzel Bausätze*  
*Kits au détail*

M9000729	M9001476	M9001477	-	M9001479	M9001010 © M9001010 ©	M9001480
----------	----------	----------	---	----------	--------------------------	----------

**TELESCOPIC T 13-30 (A) - POWER P 14-24 (A) - SYNCHRON S 14-21**

	CRANE	A	B	D	E	F	G
	INTERFACE PK SLD-EH-SH EPSILON						
M9001450		x1	x2	x1	x4	-	x1
M9001176		x1	-	x1	x4	-	x1

**Retailed kits**  
*Einzel Bausätze*  
*Kits au détail*

M9000729	M9001476	M9000337	M9001478	M9001479	M9001009 © M9001010 © M9001010 ©	M9001475
----------	----------	----------	----------	----------	--	----------

© 13->15 © 18->24 © 26->30 & P / HP 24

General accessories  
 Allgemeines Zubehör  
 Accessoires généraux

Hookloader  
 Abrollkipper  
 Polybenne

Skiploader  
 Absetzkipper  
 Multibenne

Retrofit kits  
 Nachrüstungssätze  
 Kits rétrofit

# HEAVY RANGE MOUNTING KIT 13-30 T

## SCHWERE REIHE MONTAGE BAUSATZ 13-30 T

### GAMME LOURDE KIT DE FIXATION 13-30 T

ISUZU





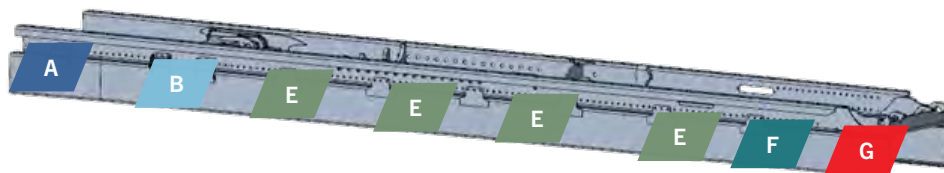

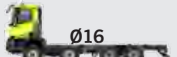

**Bolts are now to be ordered separately**  
*Schrauben sind jetzt separat zu bestellen*  
 La visserie doit maintenant être commandée séparément



### BOLTS - SCHRAUBEN - VISSERIE

		Length / Länge / Longueur (mm)				
		40	50	60	80	100
M9001465	 Ø14	M9000464 x1 (qty 50/box)	M9000465 x1 (qty 50/box)	-	-	M9000463 x1 (qty 100/box)
	 Ø16	-	M9000505 x1 (qty 50/box)	M9000506 x1 (qty 50/box)	-	M9000507 x1 (qty 100/box)

### TELESCOPIC HT 18-30 (A) - POWER HP 17-24 A - SYNCHRON HC 21

		A	B	E	F	G
M9001453	 < 7200 mm	 x1	 x2	 x6	 -	 x1
<b>Retailed kits</b> <i>Einzeln Bausätze</i> <i>Kits au détail</i>		M9001155 +M9000810	M9001155	M9000920	M9001010	M9000991

## ADDITIONAL RETAILED PARTS / Zus. Einzelteile / Pièces détaillées additionnelles

### SPACERS / Abstandsplatten / Entretoises

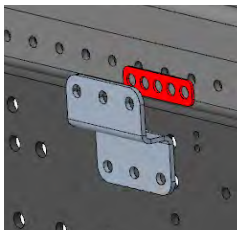

Part Nr/ Teil Nummer/ Référence	Holes diameter / Löcher Durchmesser / Diamètre perçage (mm)	Thickness / Dicke / Épaisseur (mm)	Holes step/ Löcher Schritt / Pas de perçage (mm)
M5341549_80030	16.5	2	25
M5337510	16.5	3	25
M5337511	15	3	40

### BOLTS FOR FLEXIBLE BRACKETS / Schrauben für Schubweich Befestigung / Visserie fixation souple

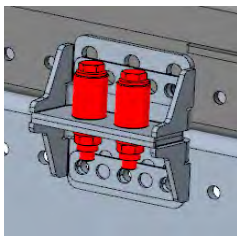

Part Nr/ Teil Nummer/ Référence	Screws diameter / Schrauben Durch- messer / Diamètre vis (mm)	Quality / Qualität / Qualité	Quantity per box / Menge pro Box / Quantité par boîte
M9000810	M14	10.9	2



# PH T SCAN MOUNTING KIT

PH T SCAN MONTAGE BAUSATZ  
PH T SCAN KIT FIXATION



General accessories  
Allgemeines Zubehör  
Accessoires généraux

Hookloader  
Abrollkipper  
Polybenne

Skiploader  
Absetzkipper  
Multibenne

Retrofit kits  
Nachrüstungssätze  
Kits retrofit

# PH T SCAN MOUNTING KIT

## PH T SCAN MONTAGE BAUSATZ

## PH T SCAN KIT FIXATION

### SCANIA P - R - G

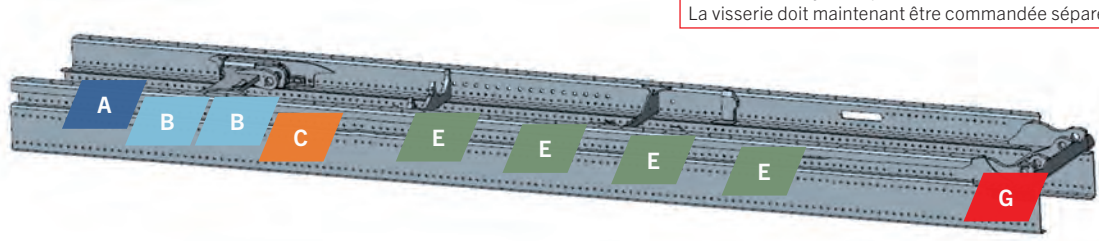

**Bolts are now to be ordered separately**  
*Schrauben sind jetzt separat zu bestellen*  
 La visserie doit maintenant être commandée séparément

### BOLTS - SCHRAUBEN - VISSERIE

		Length / Länge / Longueur (mm)					
		40	50	60	80	100	
M9001463	Ø14	M9000464 x1 (qty 50/box)	M9000465 x1 (qty 50/box)	-	M9001032 x1 (qty 25/box)	M9001033 x1 (qty 25/box)	M9000463 x2 (qty 100/box)

### TELESCOPIC PH T(A) 17-24 SCAN

	CRANE	A	B	C	E	G
	INTERFACE PK SLD-EH-SH EPSILON					
M9001446	-	x1	x2	x1	x6	x1
M9001024	x1	-	x1	x1	x3	x1

<b>Retailed kits</b> <i>Einzel Bausätze</i> <i>Kits au détail</i>	M9000729	M9000810 + M9000748	M9001165	M9001166	M9000928	M9000993
---	----------	------------------------	----------	----------	----------	----------

## RENAULT T-K -C - VOLVO FMX-FH-FM

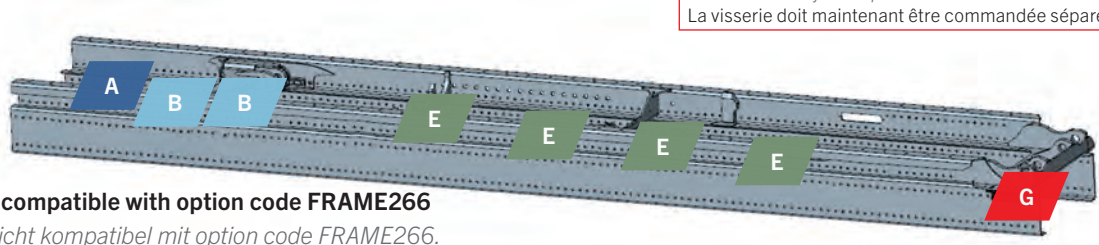

**Bolts are now to be ordered separately**  
*Schrauben sind jetzt separat zu bestellen*  
 La visserie doit maintenant être commandée séparément

**Incompatible with option code FRAME266**  
*Nicht kompatibel mit option code FRAME266.*  
*Incompatible avec code option FRAME266.*

## BOLTS - SCHRAUBEN - VISSERIE

	Ø	Length / Länge / Longueur (mm)				
		40	50	60	80	100
M9001462	Ø14	M9000464 x2 (qty 50/box)	M9000465 x2 (qty 50/box)	-	-	M9000463 x2 (qty 100/box)

## TELESCOPIC PH T(A) 17-24 SCAN

	CRANE	A	B	E	G
	INTERFACE PK SLD-EH-SH EPSILON				
M9001435	-	x1	x2	x6	x1
M9001013	x1	-	-	x6	x1
<b>Retailed kits</b> <i>Einzel Bausätze</i> <i>Kits au détail</i>	M9000730	M9000886	M9001155	M9000887	M9000993

# PH T SCAN MOUNTING KIT

## PH T SCAN MONTAGE BAUSATZ

## PH T SCAN KIT FIXATION

### MAN TGA - TGS - TGX

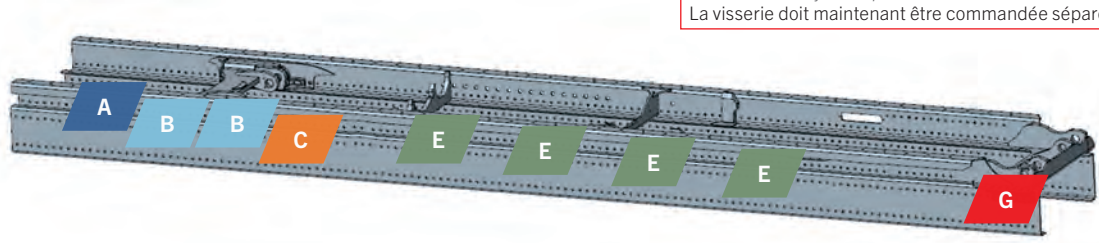

**Bolts are now to be ordered separately**  
*Schrauben sind jetzt separat zu bestellen*  
 La visserie doit maintenant être commandée séparément

### BOLTS - SCHRAUBEN - VISSERIE

		Length / Länge / Longueur (mm)					
		40	50	60	80	100	
M9001463	Ø14	M9000464 x1 (qty 50/box)	M9000465 x1 (qty 50/box)	-	M9001032 x1 (qty 25/box)	M9001033 x1 (qty 25/box)	M9000463 x2 (qty 100/box)

### TELESCOPIC PH T(A) 17-24 SCAN

	CRANE	A	B	C	E	G	
	INTERFACE PK SLD-EH-SH EPSILON						
M9001438		-	x1	x2	x1	x5	x1
M9001016		x1	-	x1	x5	x1	

#### Retailed kits

*Einzel Bausätze*  
 Kits au détail

M9000781 M9000900 M9001156 M9001156 M9000901 M9001035

## MERCEDES ACTROS NEW, ANTOS & AROCS - AIR SUSPENSION / Luftfederung / Suspension pneumatique



Mercedes-Benz

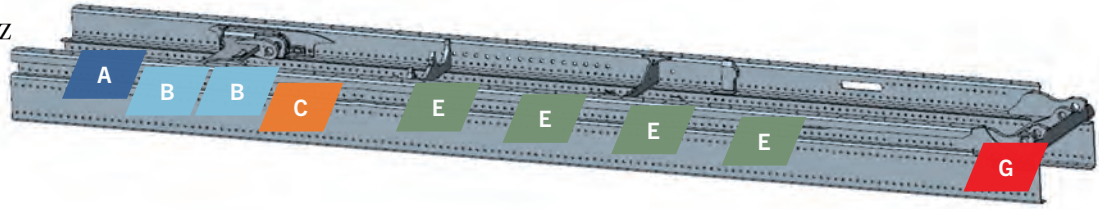



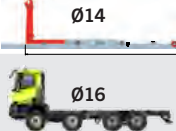

**Bolts are now to be ordered separately**  
 Schrauben sind jetzt separat zu bestellen  
 La visserie doit maintenant être commandée séparément

### BOLTS - SCHRAUBEN - VISSERIE

	Length / Länge / Longueur (mm)					
		40	50	60	80	100
M9001464 	Ø14	M9000464 x1 (qty 50/box)	M9000465 x1 (qty 50/box)	-	-	M9000463 x1 (qty 100/box)
	Ø16	-	M9000505 x1 (qty 50/box)	M9000506 x1 (qty 50/box)	M9001128 x1 (qty 50/box)	M9001129 x1 (qty 50/box)

### TELESCOPIC PH T(A) 17-24 SCAN

	CRANE	A	B	C	E	G
	INTERFACE PK SLD-EH-SH EPSILON					
M9000965	-	x1	x2	x1	x4	x1
M9001021	x1	-	-	x1	x5	x1
<b>Retailed kits</b> Einzel Bausätze Kits au détail	M9000728	M9000990	M9001160	M9001161	M9000920	M9000993

General accessories  
 Allgemeines Zubehör  
 Accessoires généraux

Hookloader  
 Abrollkipper  
 Polybenne

Skiploader  
 Absetzkipper  
 Multibenne

Retrofit kits  
 Nachrüstungssätze  
 Kits rétrofit

# PH T SCAN MOUNTING KIT

## PH T SCAN MONTAGE BAUSATZ

### PH T SCAN KIT FIXATION

DAF XD-XF-XG 6X4 / 8X2 / 8X4 - DAF XD-XF-XG 4X2 / 6X2 (← 2025/06)



**Bolts are now to be ordered separately**  
*Schrauben sind jetzt separat zu bestellen*  
 La visserie doit maintenant être commandée séparément

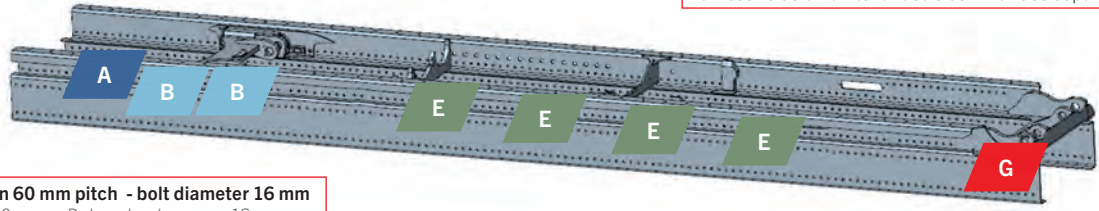

**Chassis drilling pattern 60 mm pitch - bolt diameter 16 mm**  
*Chassis Lochabstand 60 mm – Bolzendurchmesser 16 mm*  
 Perçage châssis pas de 60 mm – Diamètre boulon 16 mm

### BOLTS - SCHRAUBEN - VISSERIE

		Length / Länge / Longueur (mm)					
		40	50	60	80	100	
M9001464	Ø14	M9000464 x1 (qty 50/box)	M9000465 x1 (qty 50/box)	-	-	-	M9000463 x1 (qty 100/box)
	Ø16	-	M9000505 x1 (qty 50/box)	M9000506 x1 (qty 50/box)	M9001128 x1 (qty 50/box)	M9001129 x1 (qty 50/box)	M9000507 x1 (qty 100/box)

### TELESCOPIC PH T (A) 17-24 SCAN

	CRANE	A	B	E	G
	INTERFACE PK SLD-EH-SH EPSILON				
M9001495		x1	x2	x6	x1
M9001498		x1	-	x5	x1
<b>Retailed kits</b> <i>Einzel Bausätze</i> <i>Kits au détail</i>	M9000729	M9000943	M9001169	M9001122	M9000993

## DAF XD-XF-XG 4X2/6X2 (2025/06 →)



**Bolts are now to be ordered separately**  
*Schrauben sind jetzt separat zu bestellen*  
 La visserie doit maintenant être commandée séparément

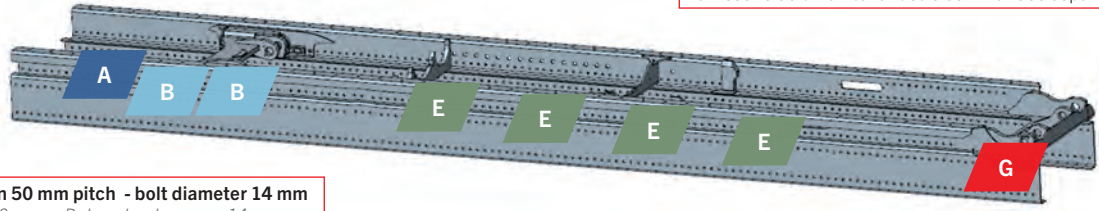

**Chassis drilling pattern 50 mm pitch - bolt diameter 14 mm**  
*Chassis Lochabstand 50 mm – Bolzendurchmesser 14 mm*  
 Perçage châssis pas de 50 mm – Diamètre boulon 14 mm

## BOLTS - SCHRAUBEN - VISSERIE

		Length / Länge / Longueur (mm)					
		40	50	60	80	100	
M9001463	Ø14	M9000464 x1 (qty 50/box)	M9000465 x1 (qty 50/box)	-	M9001032 x1 (qty 25/box)	M9001033 x1 (qty 25/box)	M9000463 x2 (qty 100/box)

## TELESCOPIC PH T (A) 17-24 SCAN

		CRANE	A	B	E	G
INTERFACE PK SLD-EH-SH EPSILON						
M9001451		x1	x2	x6	x1	
M9001123		x1	-	x1	x5	x1
<b>Retailed kits</b> <i>Einzel Bausätze</i> Kits au détail		M9000729	M9001476	M9001477	M9001479	M9001481



# MIDDLE RANGE MOUNTING KIT 5-8 T

MITTEL REIHE  
MONTAGE BAUSATZ 5-8 T  
GAMME MOYENNE  
KIT DE FIXATION 5-8 T



General accessories  
Allgemeines Zubehör  
Accessoires généraux

Hookloader  
Abrollkipper  
Polybenne

Skiploader  
Absetzkipper  
Multibenne

Retrofit kits  
Nachrüstungssätze  
Kits retrofit

# HT 05 MOUNTING KIT

## HT 05 MONTAGEBAUSATZ

## HT 05 KIT FIXATION

MAN TGL

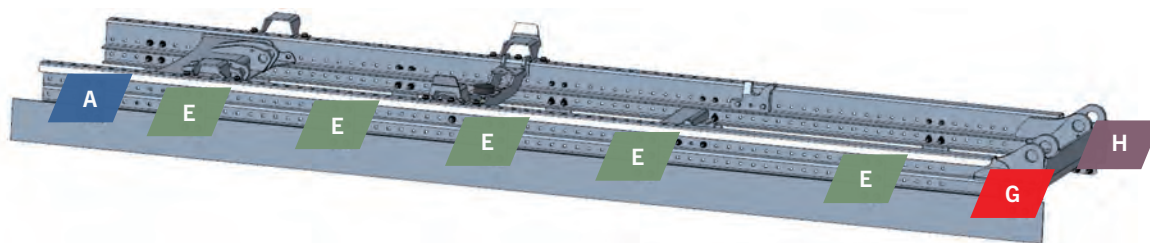

### TELESCOPIC HT 05

	A	B	D	E	F	G	H	Bolts / Schrauben / Visserie
		-	-		-			
M9001080 < 3300 mm + screws / Schrauben / Visserie	x1	-	-	x4	-	x1	x1	
M9001081 ≥3300 mm + screws / Schrauben / Visserie	x1	-	-	x5	-	x1	x1	
M9001082 < 3300 mm	x1	-	-	x4	-	x1	x1	
M9001083 ≥ 3300 mm	x1	-	-	x5	-	x1	x1	
Retailed kits	M9001104	-	-	M9001105	-	M9000812	M9000811	

RECOMMENDED ACCESSORIES

Reference / Teil Nummer / Référence	Designation / Bezeichnung / Désignation	Dimensions / Mase / Dimensions	Qty
M2375322	Pump 40 cc	Gearbox ratio 0,5	1
M2372022	Pump 18cc	Gearbox ratio 1,4	1
M2372020	Tank kit 30 l	30 l Wheel base mounted	1
M9000825	30 l tank support	For 30 l tank	1
M2371057	Tank kit 50 l	50 l Wheel base mounted	1
M9001362	Kit twin tire plastic mudguard	530 x 1020	1
M9000705	Anti-spray mudflaps kit	400x700	1
M9000400	Side protection kit	3,5 m alu profil (x4)	1
M9000481	Rear lights support kit		1
M9001287	Alu corner for reflective tape	2 x 1500mm	1
M5332091_80061	Working light support		1
M65031193	Working light 12-24 VDC		1
M5329924_80036	MAN side light support		4

## MERCEDES ATEGO



Mercedes-Benz

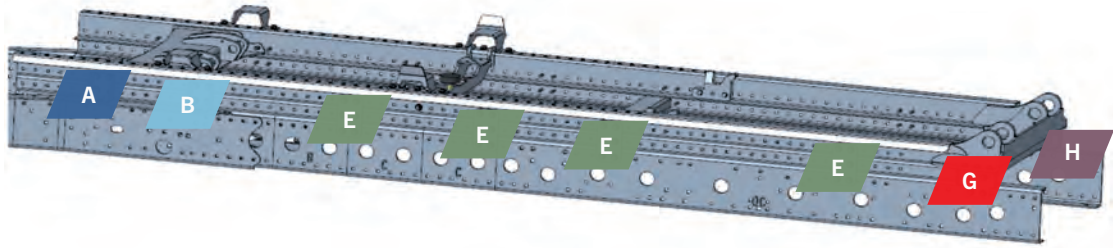

## TELESCOPIC HT 05

	A	B	D	E	F	G	H	Bolts / Schrauben / Visserie	
M9001084	< 3300 mm + screws / Schrauben / Visserie	x1	x1	-	x4	-	x1	x1	
M9001085	≥3300 mm + screws / Schrauben / Visserie	x1	x1	-	x5	-	x1	x1	
M9001086	< 3300 mm	x1	x1	-	x4	-	x1	x1	
M9001087	≥ 3300 mm	x1	x1	-	x5	-	x1	x1	
Retailed kits	M9001106	M9001116	-	M9000817	-	M9000815	M9000811		

RECOMMENDED ACCESSORIES

Reference / Teil Nummer / Référence	Designation / Bezeichnung / Désignation	Dimensions / Mase / Dimensions	Qty
M2375300	Pump 25 cc	Gearbox ratio 1	1
M2375331	Pump 32 cc	Gearbox ratio 0,8	1
M2372020	Tank kit 30 l	30 l Wheel base mounted	1
M9000825	30 l tank support	For 30 l tank	1
M2371057	Tank kit 50 l	50 l Wheel base mounted	1
M9001362	Kit twin tire plastic mudguard	530 x 1020	1
M9000705	Anti-spray mudflaps kit	400 x 700	1
M9000400	Side protection kit	3,5M alu profil (x4)	1
M9000481	Rear lights support kit		1
M9001287	Alu corner for reflective tape	2 x 1500mm	1
M5332091_80061	Working light support		1
M65031193	Working light 12-24 VDC		1
M5317314_80036	MERCEDES side light support		4

General accessories  
Allgemeines Zubehör  
Accessoires généraux

Hookloader  
Abrollkipper  
Polybenne

Skiploader  
Absetzkipper  
Multibenne

Retrofit kits  
Nachrüstungssätze  
Kits rétrofit

# HT 05 MOUNTING KIT

## HT 05 MONTAGEBAUSATZ

## HT 05 KIT FIXATION

RENAULT D75 - IVECO DAILY 65-70 C



IVECO

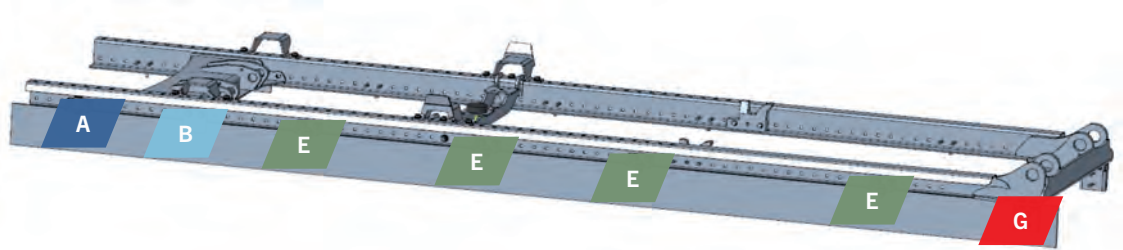

### TELESCOPIC HT 05

	A	B	D	E	F	G	H	Bolts / Schrauben / Visserie
M9001088 < 3300 mm + screws / Schrauben / Visserie	x1	x1	-	x4	-	x1	-	
M9001089 ≥3300 mm + screws / Schrauben / Visserie	x1	x1	-	x5	-	x1	-	
M9001090 < 3300 mm	x1	x1	-	x4	-	x1	-	
M9001091 ≥ 3300 mm	x1	x1	-	x5	-	x1	-	
Retailed kits	M9001107	M9001108	-	M9001109	-	M9000807	-	

RECOMMENDED ACCESSORIES

Reference / Teil Nummer / Référence	Designation / Bezeichnung / Désignation	Dimensions / Masse / Dimensions	Qty
M2375300	Pump 25 cc	Gearbox ratio 0,9-1,15	1
M2372020	Tank kit 30 l	30 l Wheel base mounted	1
M9000825	30 l tank support	For 30 l tank	1
M2371057	Tank kit 50 l	50 l Wheel base mounted	1
M9001361	Kit twin tire plastic mudguard	530 x 860	1
M9000705	Anti-spray mudflaps kit	400 x 700	1
M9000400	Side protection kit	3,5M alu profil (x4)	1
M9000481	Rear lights support kit		1
M9001287	Alu corner for reflective tape	2 x 1500mm	1
M5332091_80061	Working light support		1
M65031193	Working light 12-24 VDC		1
M5317314_80036	RENAULT TRUCKS side light support		4
No part for IVECO			

## DAF LF

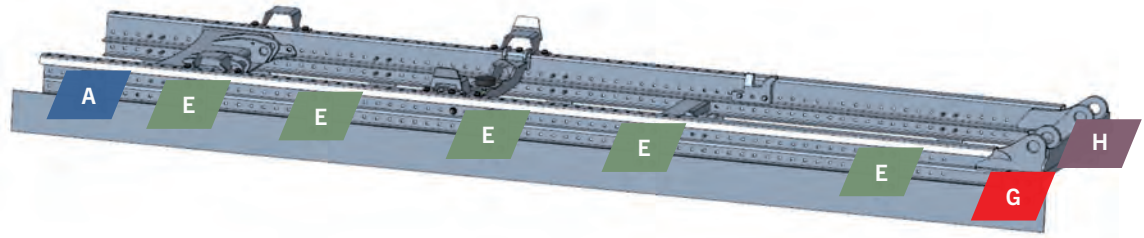

## TELESCOPIC HT 05

	A	B	D	E	F	G	H	Bolts / Schrauben / Visserie
M9001092	< 3300 mm + screws / Schrauben / Visserie	x1	-	x4	-	x1	-	
M9001093	≥ 3300 mm + screws / Schrauben / Visserie	x1	-	x5	-	x1	-	
M9001094	< 3300 mm	x1	-	x4	-	x1	-	
M9001095	≥ 3300 mm	x1	-	x5	-	x1	-	
Retailed kits	M9001110	-	-	M9000822	-	M9000820	M9000811	

### RECOMMENDED ACCESSORIES

Reference / Teil Nummer / Référence	Designation / Bezeichnung / Désignation	Dimensions / Maße / Dimensions	Qty
M2375300	Pump 25 cc	Gearbox ratio 0,9-1,15	1
M2375332	Pump 41 cc	Gearbox ratio 0,5-0,7	1
M2372020	Tank kit 30 l	30 l Wheel base mounted	1
M9000825	30 l tank support	For 30 l tank	1
M2371057	Tank kit 50 l	50 l Wheel base mounted	1
M9001362	Kit twin tire plastic mudguard	530 x 1020	1
M9000705	Anti-spray mudflaps kit	400 x 700	1
M9000400	Side protection kit	3,5M alu profil (x4)	1
M9000481	Rear lights support kit		1
M9001287	Alu corner for reflective tape	2 x 1500mm	1
M5332091_80061	Working light support		1
M65031193	Working light 12-24 VDC		1
M5329925_80036	DAF side light support		4

# HT 05 MOUNTING KIT

## HT 05 MONTAGEBAUSATZ

## HT 05 KIT FIXATION

MAN TGE - VOLKSWAGEN CRAFTER - SINGLE TIRE / Einzelreifen / Monte simple



Volkswagen

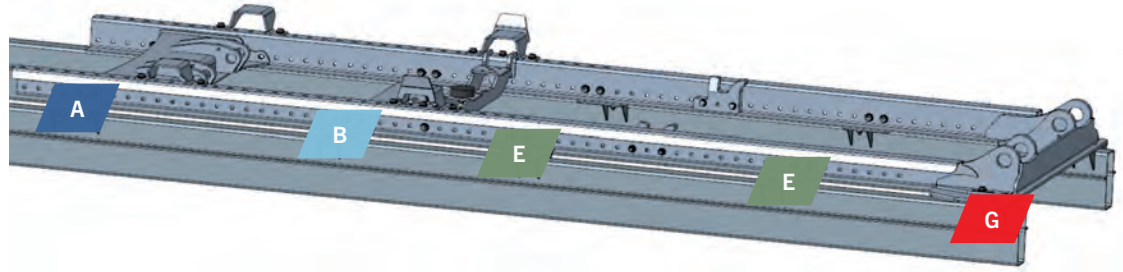

### TELESCOPIC HT 05

	A	B	D	E	F	G	H	Bolts / Schrauben / Visserie
M9001096			-		-		-	
M9001097			-		-		-	
Retailed kits	M9001111	M9000875	-	M9001112	-	M9001113	-	

Reference / Teil Nummer / Référence	Designation / Bezeichnung / Désignation	Dimensions / Mase / Dimensions	Qty
M2375300	Pump 25 cc	Gearbox ratio 0,9-1,15	1
M2372020	Tank kit 30 l	30 l Wheel base mounted	1
M9000825	30 l tank support	For 30 l tank	1
M2371057	Tank kit 50 l	50 l Wheel base mounted	1
M9000686	Kit twin tire plastic mudguard	270 x 815	1
M9000566	Fixation for 1 single mudguard	For tube diam. 34 mm	2
M9000705	Anti-spray mudflaps kit	400 x 700	1
M9000400	Side protection kit	3,5 M alu profil (x4)	1
M9000481	Rear lights support kit		1
M9001287	Alu corner for reflective tape	2 x 1500 mm	1
M5332091_80061	Working light support		1
M65031193	Working light 12-24 VDC		1

RECOMMENDED ACCESSORIES

## MAN TGE - VOLKSWAGEN CRAFTER - TWIN TIRE / Doppelreifen / Monte jumelée



Volkswagen

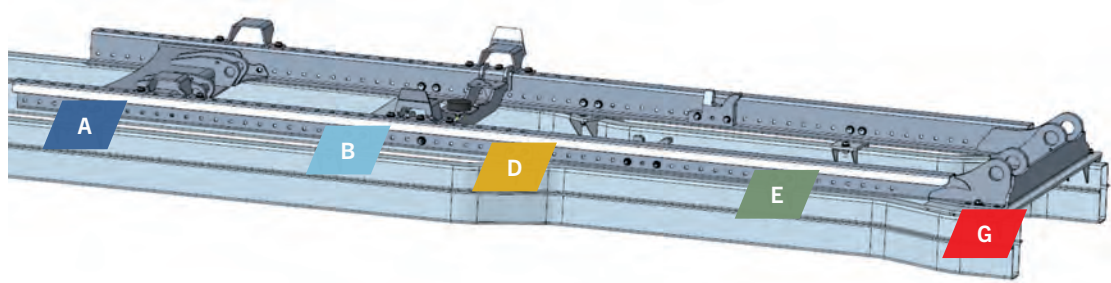

### TELESCOPIC HT 05

	A	B	D	E	F	G	H	Bolts / Schrauben / Visserie
M9001100					-		-	
< 3300 mm + screws / Schrauben / Visserie	x1	x1	x1	x1	-	x1	-	
M9001101					-		-	
≥ 3300 mm + screws / Schrauben / Visserie	x1	x2	x1	x1	-	x1	-	
Retailed kits	M9001111	M9000875	M9001114	M9001115	-	M9001113	-	

RECOMMENDED ACCESSORIES

Reference / Teil Nummer / Référence	Designation / Bezeichnung / Désignation	Dimensions / Mase / Dimensions	Qty
M2375300	Pump 25 cc	Gearbox ratio 0,9-1,15	1
M2372020	Tank kit 30 l	30 l Wheel base mounted	1
M9000825	30 l tank support	For 30 l tank	1
M2371057	Tank kit 50 l	50 l Wheel base mounted	1
M9000563	Kit twin tire plastic mudguard	455 x 860	1
M9000566	Fixation for 1 single mudguard	For tube diam. 34 mm	2
M9000705	Anti-spray mudflaps kit	400 x 700	1
M9000400	Side protection kit	3,5 M alu profil (x4)	1
M9000481	Rear lights support kit		1
M9001287	Alu corner for reflective tape	2 x 1500 mm	1
M5332091_80061	Working light support		1
M65031193	Working light 12-24 VDC		2

General accessories  
Allgemeines Zubehör  
Accessoires généraux

Hookloader  
Abrollkipper  
Polybenne

Skiploader  
Absetzkipper  
Multibenne

Retrofit kits  
Nachrüstungssätze  
Kits rétrofit

# HT 07 S - HT 08 MOUNTING KIT

HT 07 S - HT 08 MONTAGEBAUSATZ

HT 07 S - HT 08 KIT FIXATION

## RENAULT TRUCKS D – VOLVO FL 12-10

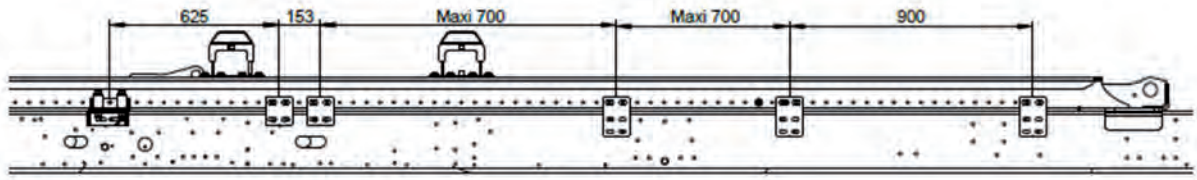

A

B

E

G

Reference	Designation	Required qty
M9000587	Screw M12x40 (qty 25/box)	3
M9000588	Nut M12 (qty 25/box)	3

## TELESCOPIC HT 07 S - HT 08

A

B

D

E





F

G

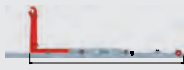
H

Bolts / Schrauben / Visserie



M9001236	L≤3950	1	2	-	3	-	1	-	
M9001238	L>3950	1	2	-	4	-	1	-	
M9001232	L≤3950	1	2	-	3	-	1	-	
M9001237	L>3950	1	2	-	4	-	1	-	
Retailed fixing kit (Left and right side)	M9001223	M9001222	-	M9001226	-	M9001219	-	-	

RECOMMENDED ACCESSORIES

Reference / Teil Nummer / Référence	Designation / Bezeichnung / Désignation	Remarks
M2372020	30 l tank	HT 08 SLD –Q<30 l/min
M9001225	30 l tank support	
M2371057	50 l tank	
M2375300	Pump XPI 25 cc – 1”1/12 & 1”	HT 08 SLD
M2375331	Pump XPI 32 cc – 1”1/12	HT 07 S SLD – HT 08 SLD
M2375332	Pump XPI 41 cc – 1”1/12	HT 07 S TEC – HT 08 TEC
M9000400	Side protection	
M9000405	Articulation kit for side protection	
M9000481	Rear lights support kit	
M9000497	Netbox	
M5341402_80036	Netbox support (to be ordered by 2)	
M9001287	Alu corner for reflective tape	
M5332091_80061	Worklight support	
M65031193	LED Worklight 12-24 VDC	
M5317314_80036	Renault truck side light support	
M9001363	Mud guard kit	
M9001198	Back vision kit	HT 07 S SLD/TEC – HT 08 SLD/TEC

## IVECO EURO CARGO

# IVECO

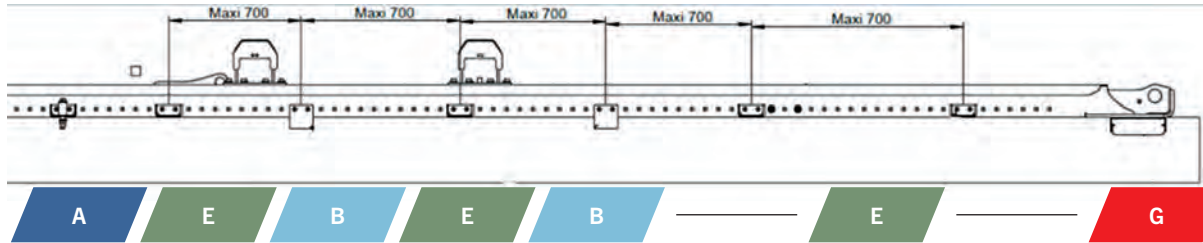

Reference	Designation	Required qty
M9000587	Screw M12x40 (qty 25/box)	2
M9000588	Nut M12 (qty 25/box)	2
M9000592	Screw M14x40 (qty 25/box)	1
M9000593	Nut M14 (qty 25/box)	1

## TELESCOPIC HT 07 S - HT 08



Reference	Designation	A	B	D	E	F	G	H	Image
M9001240	L ≤ 3950	1	2	-	5	-	1	-	
M9001242	L > 3950	1	3	-	5	-	1	-	
M9001239	L > 3950	1	2	-	5	-	1	-	
M9001241	L > 3950	1	3	-	5	-	1	-	
Retailed fixing kit (Left and right side)		M9001244	M9001243	-	M9001245	-	M9001219	-	

RECOMMENDED ACCESSORIES	Reference / Teil Nummer / Référence	Designation / Bezeichnung / Désignation	Remarks
	M2372020	30 l tank	HT 08 SLD – Q<30 l/min
	M9001225	30 l tank support	
	M9001057	50 l tank	
	M2375300	Pump XPi 25 cc – 1”1/12 & 1”	HT 08 SLD
	M2375331	Pump XPi 32 cc – 1”1/12	HT 07 S SLD – HT 08 SLD
	M2375332	Pump XPi 41 cc – 1”1/12	HT 07 S TEC – HT 08 TEC
	M9000400	Side protection	
	M9000405	Articulation kit for side protection	
	M9000481	Rear lights support kit	
	M9000497	Netbox	
	M5341402_80036	Netbox support (to be ordered by 2)	
	M9001287	Alu corner for reflective tape	
	M5332091_80061	Worklight support	
	M65031193	LED Worklight 12-24 VDC	
M5317314_80036	Truck side light support		
M9001363	Mud guard kit		
M9001198	Back vision kit	HT 07 S SLD/TEC – HT 08 SLD/TEC	

General accessories  
Allgemeines Zubehör  
Accessoires généraux

Hookloader  
Abrollkipper  
Polybenne

Skiploader  
Absetzkipper  
Multibenne

Retrofit kits  
Nachrüstungssätze  
Kits retrofit

# HT 07 S - HT 08 MOUNTING KIT

## HT 07 S - HT 08 MONTAGEBAUSATZ

## HT 07 S - HT 08 KIT FIXATION

### MAN TGL 10-12

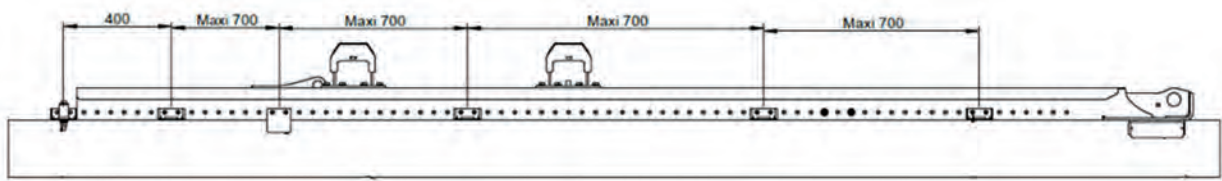

A

E

B

E

E

E

G

Reference	Designation	Required qty
M9000587	Screw M12x40 (qty 25/box)	3
M9000588	Nut M12 (qty 25/box)	3

### TELESCOPIC HT 07 S - HT 08

A

B

D

E

F

G

H

Bolts / Schrauben / Visserie

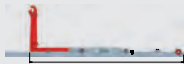

M9001268	L ≤ 3950	1	1	-	4	-	1	-	
M9001270	L > 3950	1	2	-	4	-	1	-	
M9001267	L ≤ 3950	1	1	-	4	-	1	-	
M9001269	L > 3950	1	2	-	4	-	1	-	
Retailed fixing kit (Left and right side)		M9001107	M9001108	-	M9001109	-	M9001219	-	

RECOMMENDED ACCESSORIES	Reference / Teil Nummer / Référence	Designation / Bezeichnung / Désignation	Remarks
	M2372020	30 l tank	HT 08 SLD – Q < 30 l/min
M9001225	30 l tank support		
M9001057	50 l tank		
M2375300	Pump XPI 25 cc – 1"1/12 & 1"	HT 08 SLD, PTO i=1,16	
M2375331	Pump XPI 32 cc – 1"1/12	HT 07 S SLD, PTO i=1,16	
M2375332	Pump XPI 41 cc – 1"1/12	HT 07 S TEC – HT 08 TEC, PTO i=1,16	
M2375333	Pump XPI 63 cc – 1"1/12	HT 07 S SLD – HT 08 SLD, PTO i=0,53	
M2371310	Pump XPI 80 cc – 2"	HT 07 S TEC – HT 08 TEC, PTO i=0,53	
M9000400	Side protection		
M9000405	Articulation kit for side protection		
M9000481	Rear lights support kit		
M9000497	Netbox		
M5341402_80036	Netbox support (to be ordered by 2)		
M9001287	Alu corner for reflective tape		
M5332091_80061	Worklight support		
M65031193	LED Worklight 12-24 VDC		
M5329924_80036	MAN truck side light support		
M9001363	Mud guard kit		
M9001198	Back vision kit	HT 07 S SLD/TEC – HT 08 SLD/TEC	

## MERCEDES ATEGO 10-12

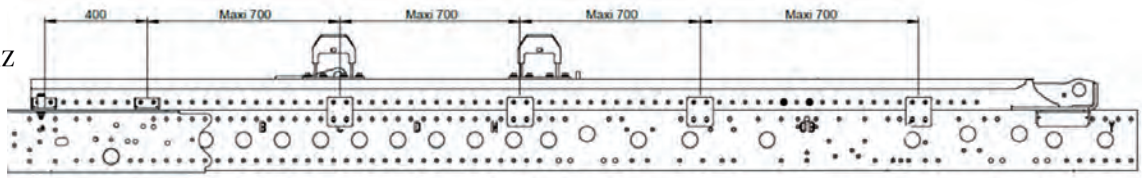

A

B

E

E

E

G

Reference	Designation	Required qty
M9000587	Screw M12x40 (qty 25/box)	3
M9000588	Nut M12 (qty 25/box)	3

## TELESCOPIC HT 07 S - HT 08

A

B

D

E



F

G

H

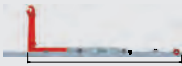
Bolts / Schrauben / Visserie

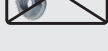

M9001254	L≤3950	1	1	-	4	-	1	-	
M9001256	L>3950	1	1	-	5	-	1	-	
M9001253	L≤3950	1	1	-	4	-	1	-	
M9001255	L>3950	1	1	-	4	-	1	-	
Retailed fixing kit (Left and right side)	M9001252	M9001251	-	M9001250	-	M9001219	-		

### RECOMMENDED ACCESSORIES

Reference / Teil Nummer / Référence	Designation / Bezeichnung / Désignation	Remarks
M2372020	30 l tank	HT 08 SLD – Q<30 l/min
M9001225	30 l tank support	
M9001057	50 l tank	
M2375300	Pump XPi 25 cc – 1”1/12 & 1”	HT 08 SLD, PTO i=1,16
M2375331	Pump XPi 32 cc – 1”1/12	HT 07 S SLD, PTO i=1,16
M2375332	Pump XPi 41 cc – 1”1/12	HT 07 S TEC – HT 08 TEC, PTO i=1,16
M2375333	Pump XPi 63 cc – 1”1/12	HT 07 S SLD – HT 08 SLD, PTO i=0,53
M2371310	Pump XPi 80 cc – 2”	HT 07 S TEC – HT 08 TEC, PTO i=0,53
M9000400	Side protection	
M9000405	Articulation kit for side protection	
M9000481	Rear lights support kit	
M9000497	Netbox	
M5341402_80036	Netbox support (to be ordered by 2)	
M9001287	Alu corner for reflective tape	
M5332091_80061	Worklight support	
M65031193	LED Worklight 12-24 VDC	
M5329924_80036	MB truck side light support	
M9001363	Mud guard kit	
M9001198	Back vision kit	HT 07 S SLD/TEC – HT 08 SLD/TEC

# HT 07 S - HT 08 MOUNTING KIT

## HT 07 S - HT 08 MONTAGEBAUSATZ

## HT 07 S - HT 08 KIT FIXATION

### ISUZU F11

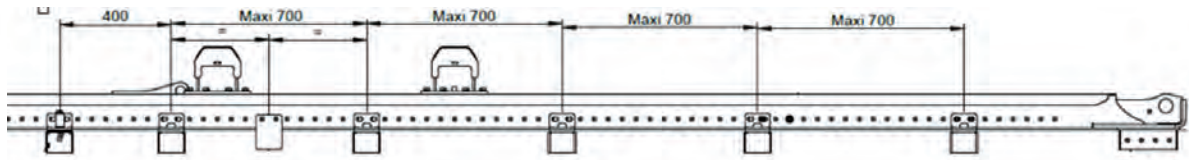

Reference	Designation	Required qty
M9000587	Screw M12x40 (qty 25/box)	3
M9000588	Nut M12 (qty 25/box)	3

### TELESCOPIC HT 07 S - HT 08



Reference	Designation	A	B	D	E	F	G	H	Remarks
M9001274	L ≤ 3950	1	1	-	6	-	1	-	
M9001276	L > 3950	1	2	-	6	-	1	-	
M9001273	L ≤ 3950	1	1	-	6	-	1	-	
M9001275	L > 3950	1	2	-	6	-	1	-	
Retailed fixing kit (Left and right side)		M9001279 + M9001282 + M9000810	M9001280	-	M9001279 + M9001282	-	M9001283	-	

#### RECOMMENDED ACCESSORIES

Reference / Teil Nummer / Référence	Designation / Bezeichnung / Désignation	Remarks
M2372020	30 l tank	HT 08 SLD – Q < 30 l/min
M9001225	30 l tank support	
M9001057	50 l tank	
M2375300	Pump XPi 25 cc – 1"1/12 & 1"	HT 08 SLD, PTO i=1,04
M2375331	Pump XPi 32 cc – 1"1/12	HT 07 S SLD – HT 08 SLD, PTO i=1,04
M2375332	Pump XPi 41 cc – 1"1/12	HT 07 S TEC – HT 08 TEC, PTO i=1,04
M2375332	Pump XPi 41 cc – 1"1/12	HT 07 S SLD – HT 08 SLD, PTO i=0,79
M2375333	Pump XPi 63 cc – 2"	HT 07 S TEC – HT 08 TEC, PTO i=0,79
M9000400	Side protection	
M9000405	Articulation kit for side protection	
M9000481	Rear lights support kit	
M9000497	Netbox	
M5341402_80036	Net box support (to be ordered by 2)	
M9001287	Alu corner for reflective tape	
M5332091_80061	Worklight support	
M65031193	LED Worklight 12-24 VDC	
M9001363	Mud guard kit	
M9001198	Back vision kit	HT 07 S SLD/TEC – HT 08 SLD/TEC

## DAF LF10

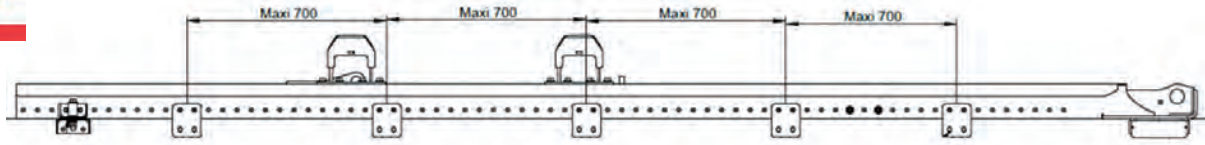

A

E

E

E

E

E

G

Reference	Designation	Required qty
M9000587	Screw M12x50 (qty 25/box)	3
M9000588	Nut M12 (qty 25/box)	3

## TELESCOPIC HT 07 S - HT 08

A

B

D

E

F

G

H

Bolts / Schrauben / Visserie

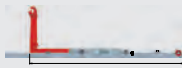

M9001264	L<=3950	1	-	-	5	-	1	-	
M9001266	L>3950	1	-	-	6	-	1	-	
M9001263	L<=3950	1	-	-	5	-	1	-	
M9001265	L>3950	1	-	-	6	-	1	-	
Retailed fixing kit (Left and right side)		M9001260 + M9001261	-	-	M9001258	-	M9001219	-	

### RECOMMENDED ACCESSORIES

Reference / Teil Nummer / Référence	Designation / Bezeichnung / Désignation	Remarks
M2372020	30 l tank	HT 08 SLD –Q<30 l/min
M9001225	30 l tank support	
M9001057	50 l tank	
M2375300	Pump XPi 25 cc – 1"1/12 & 1"	HT 08 SLD, PTO i=1,01
M2375331	Pump XPi 32 cc – 1"1/12	HT 07 S SLD, PTO i=1,01
M2375332	Pump XPi 41 cc – 1"1/12	HT 07 S TEC – HT 08 TEC, PTO i=1,01
M2375332	Pump XPi 41 cc – 1"1/12	HT 07 S SLD – HT 08 SLD, PTO i=0,67
M2375333	Pump XPi 63 cc – 2"	HT 07 S TEC – HT 08 TEC, PTO i=0,67
M2375333	Pump XPi 63 cc – 2"	HT 07 S SLD –HT 08 SLD, PTO i=0,53
M2371310	Pump XPi 80 cc – 2"	HT 07 S TEC – HT 08 TEC, PTO i=0,53
M9000400	Side protection	
M9000405	Articulation kit for side protection	
M9000481	Rear lights support kit	
M9000497	Netbox	
M5341402_80036	Net box support (to be ordered by 2)	
M9001287	Alu corner for reflective tape	
M5332091_80061	Worklight support	
M65031193	LED Worklight 12-24 VDC	
M5329925_80036	DAF truck side light support	
M9001363	Mud guard kit	
M9001198	Back vision kit	HT 07 S SLD/TEC – HT 08 SLD/TEC



# CITY MOUNTING KIT

## CITY MONTAGEBAUSATZ

### CITY KIT FIXATION



General accessories  
Allgemeines Zubehör  
Accessoires généraux

Hookloader  
Abrollkipper  
Polybenne

Skiploader  
Absetzkipper  
Multibenne

Retrofit kits  
Nachrüstungssätze  
Kits rétrofit

# CITY MOUNTING KIT



## CITY MONTAGEBAUSATZ

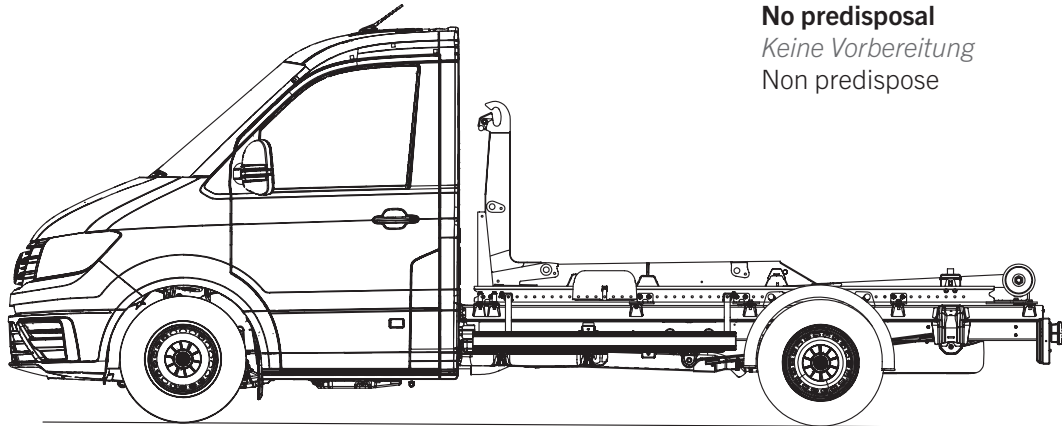

### CITY KIT FIXATION

#### MAN TGE - VOLKSWAGEN CRAFTER



**No predisposal**  
Keine Vorbereitung  
Non predispose

Vehicle (short cab) LKW (kurzes Fahrerhaus) Véhicule (cabine courte)	Wheelbase [mm] Radstand Empattement	Back cab box configuration Ausstattung Fhs Rückwand WZ-Kasten Configuration Coffre dos cabine	Wheel formula Radformel Type de monte	CiTy length [mm] / CiTy Länge / Longueur CiTy		
				2760	2910	3110
<b>MAN TGE Single Tire</b> MAN TGE Einzelreifen MAN TGE monte simple	 3640	without		-	-	M9100045

<b>MAN TGE Twin Tire</b> MAN TGE Doppelreifen MAN TGE monte jumelée	 3640	without		-	-	M9100044
---	--	---------	---	---	---	----------

Designation Bezeichnung Désignation	Reference / Referenz / Référence	
	M9100044	M9100045
<b>Mounting kit MAN TGE Twin Tire / Bausatz MAN TGE Doppelreifen / Kit fixation châssis MAN TGE monte jumelée</b>	M9000844	-
<b>Mounting kit MAN TGE Single Tire / Bausatz MAN TGE Einzelreifen / Kit fixation châssis MAN TGE monte simple</b>	-	M9000845
<b>Kit pump NPLH UNI 13 DIN12 / Kit Pumpe NPLH UNI 13 DIN 12 / Kit pompe NPLH UNI 13 Din 12 OMFB</b>	M2375307	
<b>Kit plastic mudguards / Kit Plastik-Kotflügel / Kit ailes plastiques</b>	M9000563	M9000686
<b>Kit side protection MAN TGE 3 / Kit Seitenfahrerschutz MAN TGE 3 / Kit pare-cycliste MAN TGE 3</b>	M9000874	
<b>Kit tank 20 L / Kit 20 L Tank / Kit réservoir 20 L</b>	M2375139	
<b>Kit supports for mudguards or side protection / Kit Halter für Kotflügel oder Seitenfahrerschutz / Kit supports ailes ou pare-cyclistes</b>	M9000566	
<b>Kit short supports for tank / Kit kurze Halter für Tank / Kit supports réservoir courts</b>	M9000567	
<b>Support for working light / Halter für Arbeitsscheinwerfer / Support phare de travail</b>	M5332450_80030	
<b>Screw M12x40 - per 25 / Schraube M12x40 - pro 25 / Vis M12X40 - par 25</b>	M9000587	
<b>Nut M12 - per 25 / Muttern M12 - pro 25 / Ecrou M12 - par 25</b>	M9000588	
<b>M12 Male-Female extension 5 wires 3 m / M12 Stecker Buchse Verlängerung 5-polig - 3 m / Prolongateur M12 Male-Femelle 5 fils 3 m</b>	M4701261	
<b>LED working light / LED Arbeitsscheinwerfer / Phare de travail à LED</b>	M65031193	

# MAN TGE - VOLKSWAGEN CRAFTER

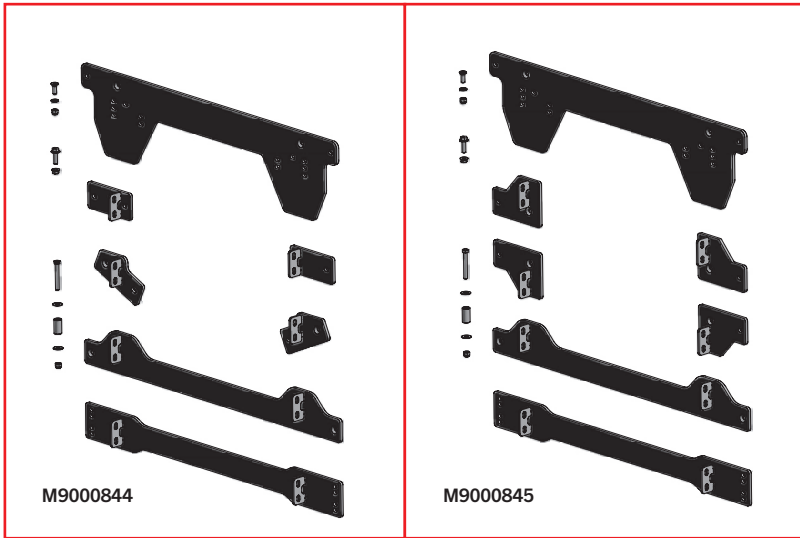

M9000844

M9000845



M4701261



M9000567



M2375307



M65031193

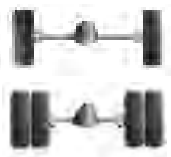

M9000686

M9000563

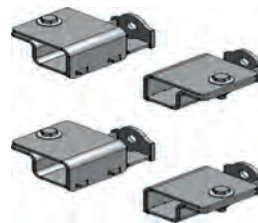

M9000566



M5332450\_80030



M9000587



M9000588



M2375139



M9000874

Only for chassis GVW ≤ 3,5 t  
 Nur für Fahrgestell ZGG ≤ 3,5 t  
 Uniquement pour châssis PTC ≤ 3,5 t

General accessories  
 Allgemeines Zubehör  
 Accessoires généraux

Hookloader  
 Abrollkipper  
 Polybenne

Skiploader  
 Absetzkipper  
 Multibenne

Retrofit kits  
 Nachrüstungssätze  
 Kits rétrofit

# CITY MOUNTING KIT

## CITY MONTAGEBAUSATZ

### CITY KIT FIXATION

#### RENAULT MASTER PRO - OPEL MOVANO

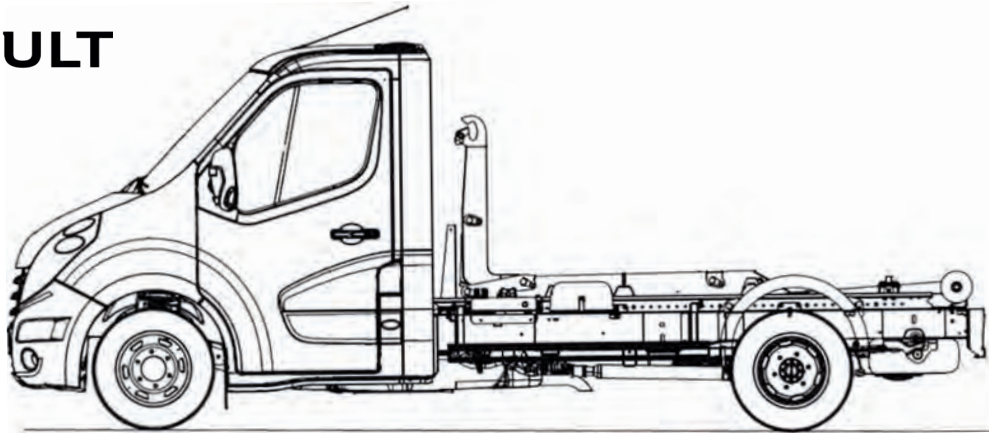

Vehicle (short cab) LKW (kurzes Fahrerhaus) Véhicule (cabine courte)	Wheelbase [mm] Radstand Empattement	Back cab box configuration Ausstattung Fhs Rückwand WZ-Kasten Configuration Coffre dos cabine	CiTy length [mm] / CiTy Länge / Longueur CiTy		
			2760	2910	3110
RENAULT MASTER PRO (twin tires)	3682	without	-	M9100015*	-
	3682	with	-	-	-
	4332	without	-	-	-
	4332	with	-	M9100016	M9100016

\* This kit can be ordered directly mounted on the hookloader at the factory, using the option PREDISPOSED MASTER PRO. / Bei Bestellung der Option PREDISPOSED MASTER PRO wird der Montagebausatz bereits ab Werk montiert. / Ce kit peut être commandé directement monté via l'option PREDISPOSED MASTER PRO.

	Designation Bezeichnung Désignation	Wheel formula Radformel Type de monte	Reference Referenz Référence
Full mounting kit MASTER PRO short / Komplettes Aufbaukit MASTER PRO kurz / Kit complet carrossage MASTER PRO court			M9100015
Full mounting kit MASTER PRO long / Komplettes Aufbaukit MASTER PRO lang / Kit complet carrossage MASTER PRO long			M9100016

	Designation Bezeichnung Désignation	Reference / Referenz / Référence
MASTER PRO Mounting kit short / Bausatz MASTER PRO kurz / Kit fixation châssis MASTER PRO court		M9100015    M9100016
MASTER PRO Mounting kit long / Bausatz MASTER PRO lang / Kit fixation châssis MASTER PRO long		M9000543    -
Kit pump NPLH UNI 13 DIN12 / Kit Pumpe NPLH UNI 13 DIN 12 / Kit pompe NPLH UNI 13 Din 12 OMFB		-    M9000574
Kit plastic mudguards / Kit Plastik-Kotflügel / Kit ailes plastiques		M2375307
Kit side protection / Kit Seitenfahrerschutz / Kit pare-cycliste		M9000563
Kit tank 20 L / Kit 20 L Tank / Kit réservoir 20 L		M9000565
Kit supports for mudguards or side protection / Kit Halter für Kotflügel oder Seitenfahrerschutz / Kit supports ailes ou pare-cyclistes		M2375139
Kit long supports for tank MASTER PRO / Kit lange Halter für Tank MASTER PRO / Kit supports réservoir longs MASTER PRO		M9000566
Support for working light / Halter für Arbeitsscheinwerfer / Support phare de travail		M9000568
Screw M12x40 - per 25 / Schraube M12x40 - pro 25 / Vis M12X40 - par 25		M5332450_80030
Nut M12 - per 25 / Muttern M12 - pro 25 / Ecrou M12 - par 25		M9000587
LED working light / LED Arbeitsscheinwerfer / Phare de travail à LED		M9000588
		M65031193

# RENAULT MASTER PRO - OPEL MOVANO



M9000574



M9000543



M9000568



M2375307



M9000563



M5332450\_80030

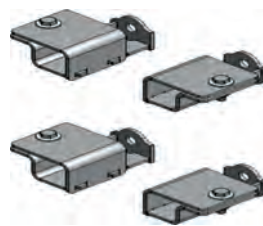

M9000566



M65031193



M9000587



M2375139



M9000588



Only for chassis GVW ≤ 3,5 t  
Nur für Fahrgestell ZGG ≤ 3,5 t  
Uniquement pour châssis PTC ≤ 3,5 t

M9000565

# CITY MOUNTING KIT

## CITY MONTAGEBAUSATZ

### CITY KIT FIXATION

IVECO DAILY

IVECO

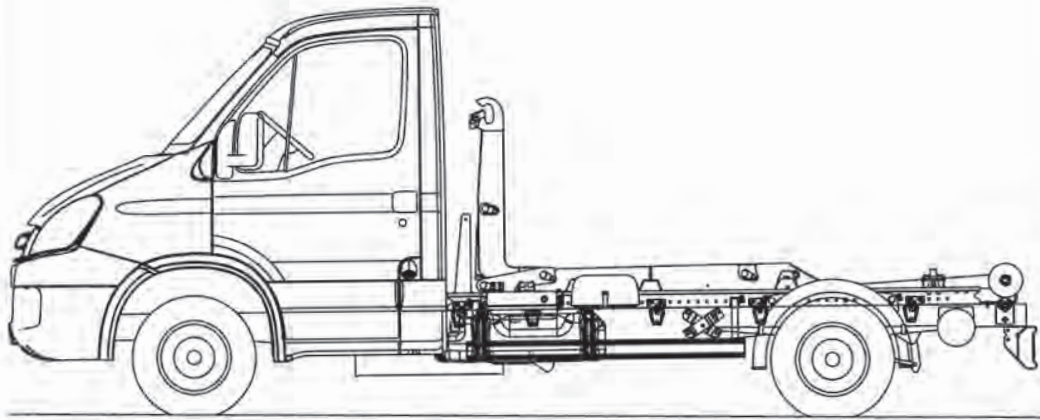

Vehicle (short cab) LKW (kurzes Fahrerhaus) Véhicule (cabine courte)	Wheelbase [mm] Radstand Empattement	Back cab box configuration Ausstattung Fhs Rückwand WZ-Kasten Configuration Coffre dos cabine	CiTy length [mm] / CiTy Länge / Longueur CiTy		
			2760	2910	3110
IVECO DAILY	3000	without	M9100019	-	-
	3450	without	-	M9100019*	M9100019*
	3750	without	-	M9100020	M9100020
	3750	with	M9100020	M9100020	-
	4100	with	M9100020	M9100020	M9100020

\* This kit can be ordered directly mounted on the hookloader at the factory, using the option PREDISPOSED IVECO DAILY. / Bei Bestellung der Option PREDISPOSED IVECO DAILY wird der Montagebausatz bereits ab Werk montiert. / Ce kit peut être commandé directement monté via l'option PREDISPOSED IVECO DAILY.

Designation Bezeichnung Désignation	Wheel formula / Radformel / Type de monte	Reference Referenz Référence
Full mounting kit DAILY short / Komplettes Aufbaukit DAILY kurz / Kit complet carrossage DAILY court		M9100019
Full mounting kit DAILY long / Komplettes Aufbaukit DAILY lang / Kit complet carrossage DAILY long		M9100020

Designation Bezeichnung Désignation	Reference / Referenz / Référence
Mounting kit DAILY short / Bausatz DAILY kurz / Kit fixation châssis DAILY court	M9000547 -
Mounting kit DAILY long / Bausatz DAILY lang / Kit fixation châssis DAILY long	- M9000573
Kit pump NPLH UNI 13 DIN12 / Kit Pumpe NPLH UNI 13 DIN 12 / Kit pompe NPLH UNI 13 Din 12 OMFB	M2375307
Kit plastic mudguards / Kit Plastik-Kotflügel / Kit ailes plastiques	M9000563
Kit side protection / Kit Seitenfahrerschutz / Kit pare-cycliste	M9000565
Kit tank 20 L / Kit 20 L Tank / Kit réservoir 20 L	M2375139
Kit supports for mudguards or side protection / Kit Halter für Kotflügel oder Seitenfahrerschutz / Kit supports ailes ou pare-cyclistes	M9000566
Kit short supports for tank / Kit kurze Halter für Tank / Kit supports réservoir courts	M9000567
Support for working light / Halter für Arbeitsscheinwerfer / Support phare de travail	M5332450_80030
Screw M12x40 - per 25 / Schraube M12x40 - pro 25 / Vis M12X40 - par 25	M9000587
Nut M12 - per 25 / Muttern M12 - pro 25 / Ecrou M12 - par 25	M9000588
LED working light / LED Arbeitsscheinwerfer / Phare de travail à LED	M65031193

# IVECO DAILY

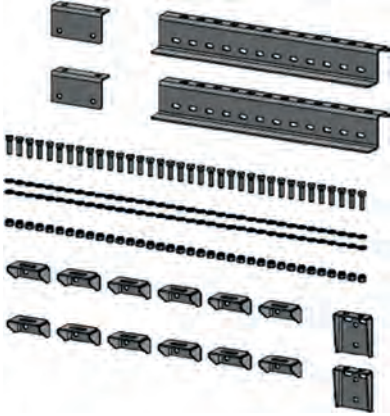

M9000573

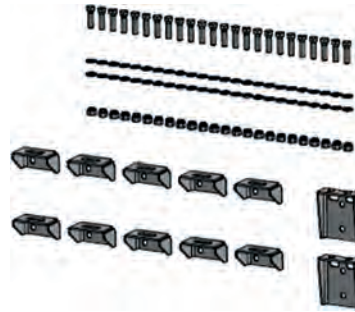

M9000547



M9000563



M2375307



M9000567



M2375139



M5332450\_80030



M65031193

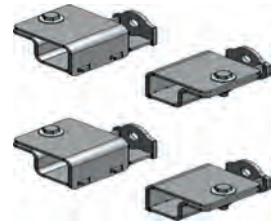

M9000566



M9000587



M9000588



Only for chassis GVW ≤ 3,5 t  
Nur für Fahrgestell ZGG ≤ 3,5 t  
Uniquement pour châssis PTC ≤ 3,5 t

M9000565

# CITY MOUNTING KIT

## CITY MONTAGEBAUSATZ

### CITY KIT FIXATION

#### FUSO CANTER 3CXX - 2022

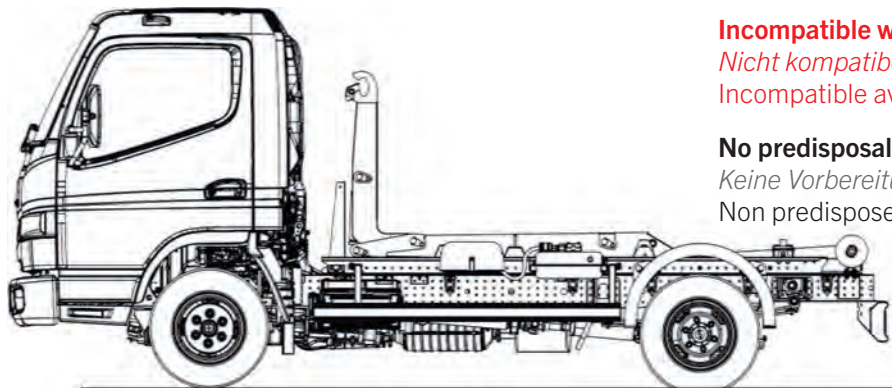

**Incompatible with 3S chassis**  
*Nicht kompatibel mit 3S Chassis*  
 Incompatible avec châssis 3S

**No predisposal**  
*Keine Vorbereitung*  
 Non predispose

Vehicle (short cab) <i>LKW (kurzes Fahrerhaus)</i> <i>Véhicule (cabine courte)</i>	Wheelbase [mm] <i>Radstand</i> <i>Empattement</i>	Back cab box configuration <i>Ausstattung Fhs Rückwand WZ-Kasten</i> <i>Configuration Coffre dos cabine</i>	CiTy length [mm] / <i>CiTy Länge</i> / <i>Longueur CiTy</i>		
			2760	2910	3110
FUSO CANTER 3Cxx	2500	without	M9100055	M9100055	-
	2800	without	-	M9100055	M9100055
	2800	with	M9100056	-	-
	3400	without	-	-	-
	3400	with	M9100056	M9100056	M9100056
	3850	without	-	-	-
	3850	with	-	-	-

	Designation <i>Bezeichnung</i> <i>Désignation</i>	Wheel formula <i>Radformel</i> <i>Type de monte</i>	Reference <i>Referenz</i> <i>Référence</i>
Full mounting kit FUSO CANTER short / <i>Komplettes Aufbaukit FUSO CANTER kurz</i> / <i>Kit complet carrossage FUSO CANTER court</i>			M9100055
Full mounting kit FUSO CANTER long / <i>Komplettes Aufbaukit FUSO CANTER lang</i> / <i>Kit complet carrossage FUSO CANTER long</i>			M9100056

	Designation <i>Bezeichnung</i> <i>Désignation</i>	Reference / <i>Referenz</i> / <i>Référence</i>
FUSO CANTER Mounting kit short / <i>FUSO CANTER kurz</i> / <i>Kit fixation châssis FUSO CANTER court</i>		M9001326 -
FUSO CANTER Mounting kit long / <i>FUSO CANTER lang</i> / <i>Kit fixation châssis FUSO CANTER long</i>		- M9001327
Kit pump OMFB 12cc + ISO adapter / <i>Kit pump OMFB 12cc + ISO adapter</i> / <i>Kit pump OMFB 12cc + ISO adapter</i>		M2375310
Kit plastic mudguards / <i>Kit Plastik-Kotflügel</i> / <i>Kit ailes plastiques</i>		M9000563
Kit side protection / <i>Kit Seitenfahrerschutz</i> / <i>Kit pare-cycliste</i>		M9000642
Kit tank 20 l / <i>Kit 20 l Tank</i> / <i>Kit réservoir 20 l</i>		M2375345
Kit supports for mudguards or side protection / <i>Kit Halter für Kotflügel oder Seitenfahrerschutz</i> / <i>Kit supports ailes ou pare-cyclistes</i>		M9000566
Kit short supports for tank / <i>Kit kurze Halter für Tank</i> / <i>Kit supports réservoir courts</i>		M9000567
Support for working light / <i>Halter für Arbeitsscheinwerfer</i> / <i>Support phare de travail</i>		M5332450_80030
Kit spare wheel support / <i>Kit Halter für Reserverad</i> / <i>Kit support porte roue de secours</i>		M9000644
Screw M10x40 - per 25 / <i>Schraube M10x40 - pro 25</i> / <i>Vis M10x40 - par 25</i>		M9000589
Nut M10 - per 25 / <i>Muttern M10 - pro 25</i> / <i>Ecrou M10 - par 25</i>		M9000597
LED working light / <i>LED Arbeitsscheinwerfer</i> / <i>Phare de travail à LED</i>		M65031193
M12 Male-Female extension 5 wires 3 m / <i>M12 Stecker Buchse Verlängerung 5-polig - 3 m</i> / <i>Prolongateur M12 Male-Femelle 5 fils 3 m</i>		M4701261

# FUSO CANTER 3CXX

M9001326

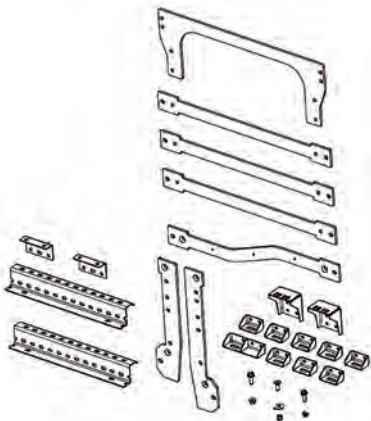

M9001327

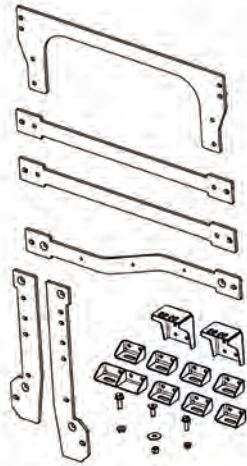

M4701261



M2375310



M9000567



M9000563



M65031193



M2375345



M5332450\_80030

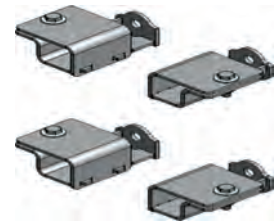

M9000566



M9000644



M9000589



M9000590



M9000642

Only for chassis GVW ≤ 3,5 t  
 Nur für Fahrgestell ZGG ≤ 3,5 t  
 Uniquement pour châssis PTC ≤ 3,5 t

General accessories  
 Allgemeines Zubehör  
 Accessoires généraux

Hookloader  
 Abrollkipper  
 Polybenne

Skiploader  
 Absetzkipper  
 Multibenne

Retrofit kits  
 Nachrüstungssätze  
 Kits rétrofit

# CITY MOUNTING KIT

## CITY MONTAGEBAUSATZ

### CITY KIT FIXATION

#### MERCEDES SPRINTER 3XX CDI - 5XX



Mercedes-Benz

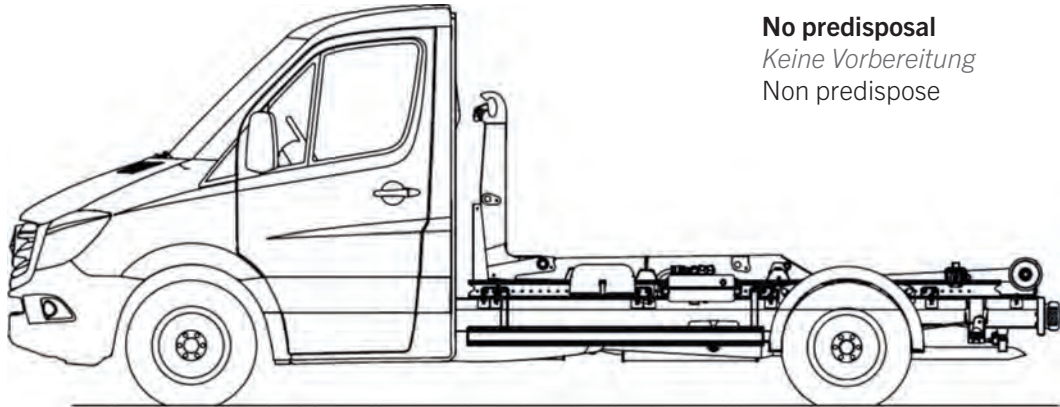

**No predisposal**

*Keine Vorbereitung*

Non predispose

Vehicle (short cab) <i>LKW (kurzes Fahrerhaus)</i> Véhicule (cabine courte)	Wheelbase [mm] <i>Radstand</i> Empattement	Back cab box configuration <i>Ausstattung Fhs Rückwand WZ-Kasten</i> Configuration Coffre dos cabine	City length [mm] <i>City Länge</i> Longueur City
MERCEDES SPRINTER 3xx CDI	3665	without	3110

Designation <i>Bezeichnung</i> Désignation	Wheel formula / <i>Radformel</i> Type de monte	Reference <i>Referenz</i> Référence
Full mounting kit MB SPRINTER 3xxCDI single tire <i>Komplettes Aufbaukit MB SPRINTER 3xxCDI Einzelreifen</i> Kit complet carrossage MB SPRINTER 3xx CDI monte simple		M9100038
Full mounting kit MB SPRINTER 3xxCDI twin tire <i>Komplettes Aufbaukit MB SPRINTER 3xxCDI Doppelreifen</i> Kit complet carrossage MB SPRINTER 3xx CDI monte jumelée		M9100049

Designation <i>Bezeichnung</i> Désignation	Reference / <i>Referenz</i> / <i>Référence</i>
Mounting kit MB SPRINTER 3xx single tire / <i>Bausatz MB SPRINTER 3xx Einzelreifen</i> / Kit de fixations MB SPRINTER 3xx monte simple	M9000658 -
Mounting kit MB SPRINTER 3xxCDI twin tire / <i>Bausatz MB SPRINTER 3xxCDI Doppelreifen</i> / Kit de fixations MB SPRINTER 3xx CDI monte jumelée	- M9001181
Kit pump NHLP20+ADAPT 4 points ISO MB / <i>Kit Pumpe NHLP 20+ Adapt. 4 pts ISO MB</i> / Kit pompe NHLP 20+ADAPT 4 pts ISO MB	M2375311
Kit Plastic mudguards / <i>Kit Plastik-Kotflügel</i> / Kit Ailes plastiques	M9000686 M9000563
Kit Side protection / <i>Kit Seitenfahrerschutz</i> / Kit pare-cycliste	M9000687
Kit tank 20 l / <i>Kit 20 l Tank</i> / Kit réservoir 20 l	M2375139
Kit supports for mudguards or side protection / <i>Kit Halter für Kotflügel oder Seitenfahrerschutz</i> / Kit supports ailes ou pare-cyclistes	M9000566
Kit short supports for tank / <i>Kit kurze Halter für Tank</i> / Kit supports réservoir courts	M9000567
Support for working light / <i>Halter für Arbeitsscheinwerfer</i> / Support phare de travail	M5332450_80030
Screw M12x40 - per 25 / <i>Schraube M12x40 - pro 25</i> / Vis M12x40 - par 25	M9000587
Nut M12 - per 25 / <i>Muttern M12 - pro 25</i> / Ecrou M12 - par 25	M9000588
LED working light / <i>LED Arbeitsscheinwerfer</i> / Phare de travail à LED	M65031193
Kit Hose support / <i>Kit Schlauchhalter</i> / Kit support flexible	M2375168
M12 Male-Female extension 5 wires 3 m / <i>M12 Stecker Buchse Verlängerung 5-polig 3 m</i> / Prolongateur M12 Male-Femelle 5 fils 3 m	M4701261

# MERCEDES SPRINTER 3XX CDI - 5XX

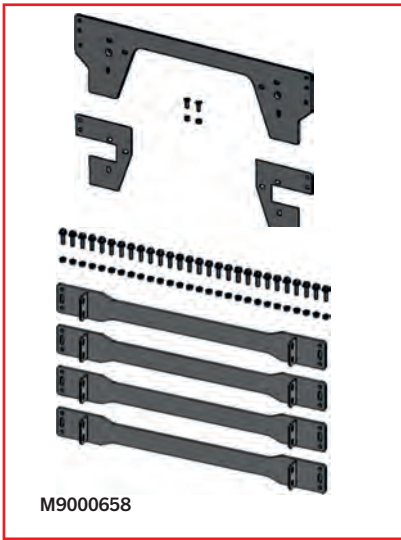

M9000658

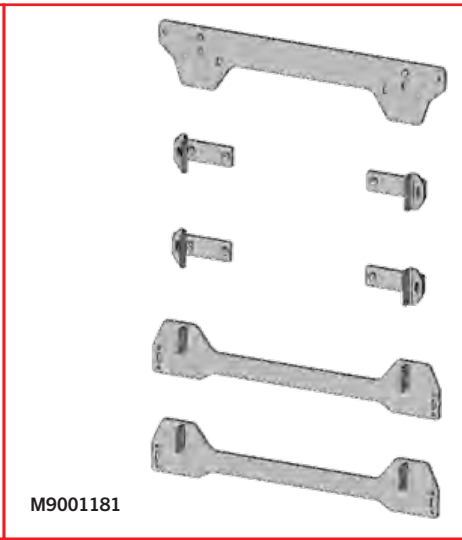

M9001181



M2375168



M65031193



M9000567



M2375311



M4701261

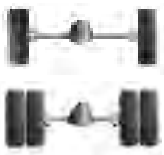

M9000686



M9000563



M9000587



M9000588

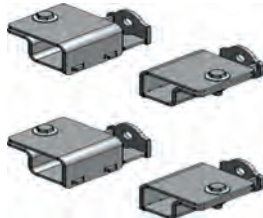

M9000566



M5332450\_80030



M2375139



M9000687

Only for chassis GVW ≤ 3,5 t  
 Nur für Fahrgestell ZGG ≤ 3,5 t  
 Uniquement pour châssis PTC ≤ 3,5 t

General accessories  
 Allgemeines Zubehör  
 Accessoires généraux

Hookloader  
 Abrollkipper  
 Polybenne

Skiploader  
 Absetzkipper  
 Multibenne

Retrofit kits  
 Nachrüstungssätze  
 Kits rétrofit

# CITY MOUNTING KIT

## CITY MONTAGEBAUSATZ

### CITY KIT FIXATION

FIAT DUCATO - PEUGEOT BOXER - CITROEN JUMPER

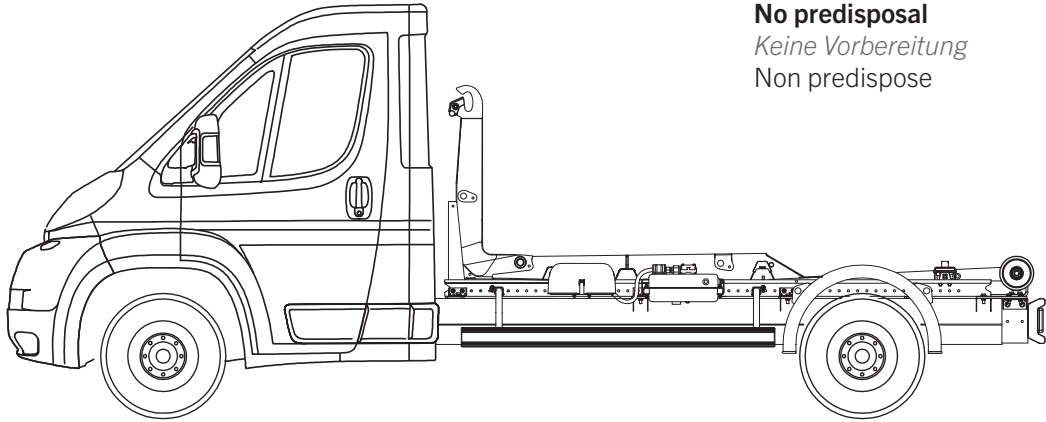

**No predisposal**

*Keine Vorbereitung*

Non predispose

Vehicle (short cab) <i>LKW (kurzes Fahrerhaus)</i> <i>Véhicule (cabine courte)</i>	Wheel formula / <i>Radformel /</i> <i>Type de monte</i>	Wheelbase [mm] <i>Radstand</i> <i>Empattement</i>	Back cab box configuration <i>Ausstattung Fhs Rückwand WZ-Kasten</i> <i>Configuration Coffre dos cabine</i>	City length [mm] <i>City Länge</i> <i>Longueur City</i>
FIAT DUCATO		3800	without	3110

Designation <i>Bezeichnung</i> <i>Désignation</i>	Reference <i>Referenz</i> <i>Référence</i>
Mounting kit FIAT DUCATO / <i>Bausatz FIAT DUCATO</i> / Kit de fixations FIAT DUCATO	M9000791
Power pack 12 V / <i>POWER PACK 12 V</i> / Groupe electro pompe 12 V	M2375128
Kit 20 l Tank / <i>Bausatz 20 l Tank</i> / Kit 20 l réservoir	M2375139
Kit Plastic mudguards / <i>Bausatz Plastik-Kotflügel</i> / Kit Ailes plastiques	M9000686
Kit Side protection / <i>Bausatz Seitenfahrerschutz</i> / Kit pare-cycliste	M9000687
Kit supports for mudguards or side protection / <i>Kit Halter für Kotflügel oder Seitenfahrerschutz</i> / Kit supports ailes ou pare-cyclistes	M9000566
Tank Support / <i>Tankhalter</i> / Support réservoir	M5334486_80
Support for working light / <i>Halter für Arbeitsscheinwerfer</i> / Support phare de travail	M5332450_80030
Screw M12x40 - per 25 / <i>Schraube M12x40 - pro 25</i> / Vis M12x40 - par 25	M9000587
Nut M12 - per 25 / <i>Muttern M12 - pro 25</i> / Ecrou M12 - par 25	M9000588
LED working light / <i>LED Arbeitsscheinwerfer</i> / Phare de travail à LED	M65031193

FIAT DUCATO - PEUGEOT BOXER - CITROEN JUMPER

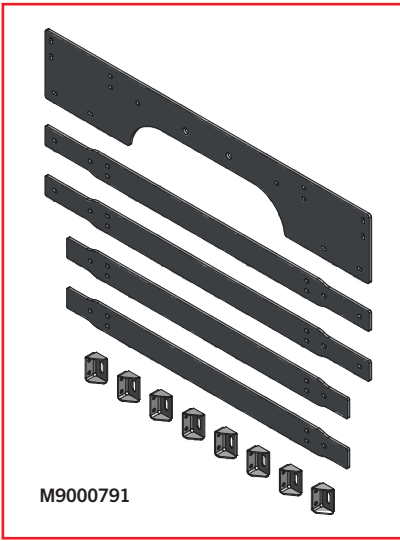

M9000791



M5332450\_80030



M65031193

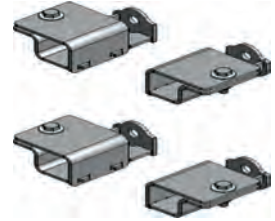

M9000566



M9000686



M9000587



M9000588



Only for chassis GVW ≤ 3,5 t  
Nur für Fahrgestell ZGG ≤ 3,5 t  
Uniquement pour châssis PTC ≤ 3,5 t

M9000687

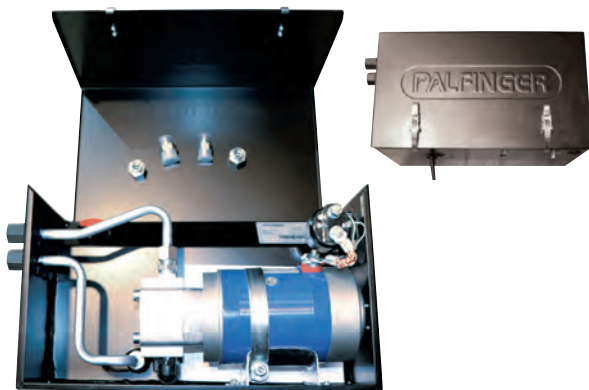

M2375128

General accessories  
Allgemeines Zubehör  
Accessoires généraux

Hookloader  
Abrollkipper  
Polybenne

Skiploader  
Absetzkipper  
Multibenne

Retrofit kits  
Nachrüstungssätze  
Kits rétrofit

# CITY MOUNTING KIT

## CITY MONTAGEBAUSATZ

### CITY KIT FIXATION

**UNIVERSAL / Universal / Universel**

Designation Bezeichnung Désignation	Reference Referenz Référence
UNIVERSAL Mounting kit / Bausatz UNIVERSAL / Kit fixation châssis UNIVERSEL	M9000579
Kit pump NPLH UNI 13 DIN12 / Kit Pumpe NPLH UNI 13 DIN 12 / Kit pompe NPLH UNI 13 Dln 12 OMFB	M2375307
Kit plastic mudguards for twin tyre / Kit Plastik-Kotflügel Kit ailes plastiques monte jumelée	M9000563
Kit plastic mudguards for single tyre / Kit Plastik-Kotflügel / Kit ailes plastiques monte simple	M9000686
Kit side protection MASTER PRO - DAILY / Kit Seitenfahrerschutz MASTER PRO - DAILY / Kit pare-cycliste MASTER PRO - DAILY	M9000565
Kit tank 20 l / Kit 20 l Tank / Kit réservoir 20 l CiTy	M2375139
Kit supports for mudguards or side protection / Kit Halter für Kotflügel oder Seitenfahrerschutz / Kit supports ailes ou pare-cyclistes	M9000566
Kit short supports for tank MAXITY / DAILY / Kit kurze Halter für Tank MAXITY / DAILY / Kit supports réservoir courts MAXITY / DAILY	M9000567
Support for working light / Halter für Arbeitsscheinwerfer / Support phare de travail	M5332450_80030
Screw M 12x40 - per 25 / Schraube M12x40 - pro 25 / Vis M12x40 - par 25	M9000587
Nut M12 - per 25 / Muttern M12 - pro 25 / Ecrou M12 - par 25	M9000588
M12 Male-Female extension 5 wires 3 m / M12 Stecker Buchse Verlängerung 5-polig - 3 m / Prolongateur M12 Male-Femelle 5 fils 3 m	M4701261
LED working light / LED Arbeitsscheinwerfer / Phare de travail à LED	M65031193

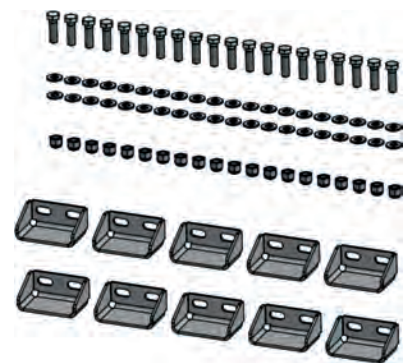

M9000579



M4701261

Only for chassis GVW ≤ 3,5 t  
Nur für Fahrgestell ZGG ≤ 3,5 t  
Uniquement pour châssis PTC ≤ 3,5 t



M9000565



M9000588



M9000587



M9000566



M2375307



M2375139



M9000567



M65031193



M5332450\_80030



M9000686

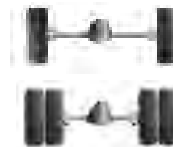

M9000563

# MISCELLANEOUS

## SONSTIGES

## DIVERS

**BACK CAB BOX / Rückwand Werkzeugkasten / Coffre dos cabine**

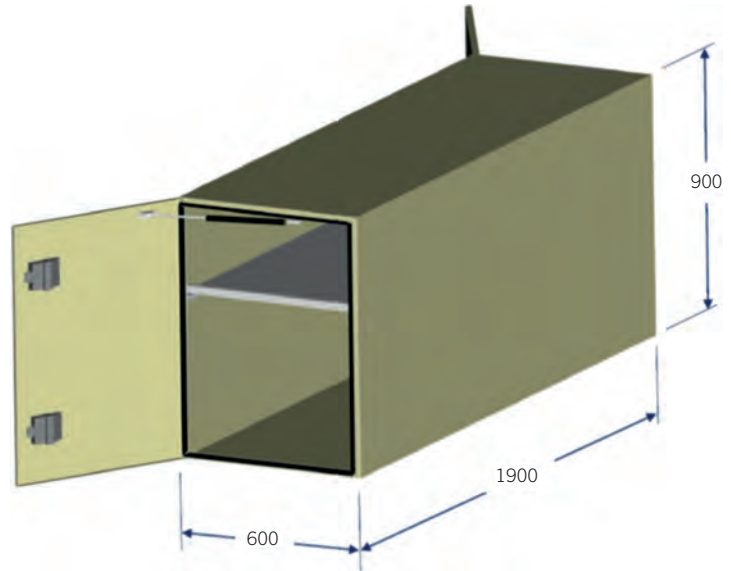

Designation Bezeichnung Désignation	 kg	Reference Referenz Référence
<b>Aluminium back cab box</b> Aluminium Werkzeugkasten (Rückwand) Coffre Aluminium dos cabine	63	M9000660

General accessories  
Allgemeines Zubehör  
Accessoires généraux

Hookloader  
Abrollkipper  
Polybenne

Skiploader  
Absetzkipper  
Multibenne

Retrofit kits  
Nachrüstungssätze  
Kits rétrofit



# MISCELLANEOUS

## SONSTIGES

## DIVERS

### POWER PACK / Power Pack / Kit électro-pompe



Designation Bezeichnung Désignation	Reference Referenz Référence	Lifting capacity [t] Ladekapazität Capacité de levage	 [mm]	 kg
<b>Power Pack 12 V</b> Power Pack 12 V Kit électro-pompe 12 V	<b>M2375128</b>	< 4	440x231x280	14
<b>Power Pack 24 V</b> Power Pack 24 V Kit électro-pompe 24 V	<b>M2375129</b>	< 4	440x231x280	14

**6 l tank included**

*6 l Tank inklusiv*

*Réservoir 6 l intégré*

Hydraulic / Electric Schematic

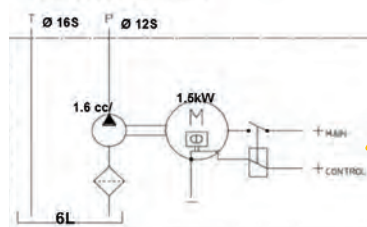

**In case of Power pack 12 VDC, the loading capacity is decreased of about 40%**

*Mit Power Pack 12 VDC die Hubkapazität wird von etwa 40% reduziert*

*Dans le cas d'un groupe électro-pompe 12 VDC, la capacité de levage est réduite de 40%*

### POWER SUPPLY CABLE POWER PACK / NETZTEILKABEL Power Pack / Câble alimentation électro-pompe



Reference Referenz Référence	Section [mm <sup>2</sup> ] Sektion Section	Length [mm] Länge Longueur	Voltage[VDC] Stromspannung Tension
<b>EEA16408</b>	<b>70</b>	<b>3000</b>	<b>12 / 24</b>

# SKIPLOADER INSTALLATION

## ABSETZKIPPER AUFBAU INSTALLATION MULTIBENNE

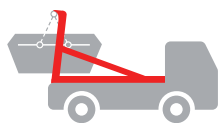

General accessories  
Allgemeines Zubehör  
Accessoires généraux

Hookloader  
Abrollkipper  
Polybenne

Skiploader  
Absetzkipper  
Multibenne

Retrofit kits  
Nachrüstungssätze  
Kits retrofit

# TARP SYSTEM PALCOVER S

## PLANENSYSTEME PALCOVER S

## SYSTÈME DE BÂCHAGE PALCOVER S

	Designation Bezeichnung Désignation	Reference Referenz Référence	 kg
<p><b>PALCOVER S-F</b></p> 	<p><b>PALCOVER S-F(fix) with tarp - net without flaps</b>  <i>PALCOVER SF (Fix) mit Plane - Netz ohne Laschen</i>            PALCOVER SF (fixe) bâche filet sans rabats</p> <p><b>Skiploader option code required</b>  <i>Option für Absetzkipper erforderlich</i>            Option nécessaire sur le multibenne : <b>9601 + 9639</b></p>	<p>M9001418</p> <p><b>NEW!</b></p>	160
<p><b>PALCOVER S-R</b></p> 	<p><b>PALCOVER S-R with tarp - net without flaps</b>  <i>PALCOVER S-R mit Plane - Netz ohne Laschen</i>            PALCOVER S-R bâche filet sans rabats</p> <p><b>Skiploader option code required</b>  <i>Option für Absetzkipper erforderlich</i>            Option nécessaire sur le multibenne : <b>9601 + 9639</b></p>	<p>M9001419</p> <p><b>NEW!</b></p>	300
<p><b>PALCOVER S-E</b></p> 	<p><b>PALCOVER S-E with tarp - net without flaps</b>  <i>PALCOVER S-E mit Plane - Netz ohne Laschen</i>            PALCOVER S-E bâche filet sans rabats</p> <p><b>Not possible with option 9601</b>  <i>Mit Option 9601 nicht möglich</i>            Pas possible avec option 9601</p>	 <p>M9000793</p>	200
<p><b>PALCOVER S-M</b></p> 	<p><b>PALCOVER S-M with tarp - net without flaps</b>  <i>PALCOVER S-M mit Plane - Netz ohne Laschen</i>            PALCOVER S-M bâche filet sans rabats</p> <p><b>Not possible with option 9601</b>  <i>Mit Option 9601 nicht möglich</i>            Pas possible avec option 9601</p>	<p>M9000792</p>	195
	<p><b>Kit back cab. Tank 120 l + support for Palcover S-E / S-M</b>  <i>Fhs Rückwand Tank 120 l + Halter für Palcover S-E / S-M</i>            Kit réservoir 120 l + support pour Palcover S-E / S-M</p>	<p>M9000801</p>	-
	<p><b>RRC for PALCOVER H-E / S-E / SA-T</b>  <i>FFS für PALCOVER H-E / S-E / SA-T</i>            Radio commande pour PALCOVER H-E / S-E / SA-T</p>	<p>M65031117</p>	-
	<p><b>Tarp - net without flaps</b>  <i>Plane - Netz ohne Laschen</i>            Bâche filet sans rabats</p>	<p>S-E S-M</p> <p>M2391020</p>	18

\* product info on <https://extranet.palfinger.com/paldesk/product-information>



# SKIPLOADER MOUNTING KIT

## ABSETZKIPPER MONTAGEBAUSATZ

### MULTIBENNE KIT FIXATION

#### RENAULT T-K-C / VOLVO FMX-FH-FM



Incompatible with option code **FRAME266**

*Nicht kompatibel mit option code FRAME266.*

*Incompatible avec code option FRAME266.*

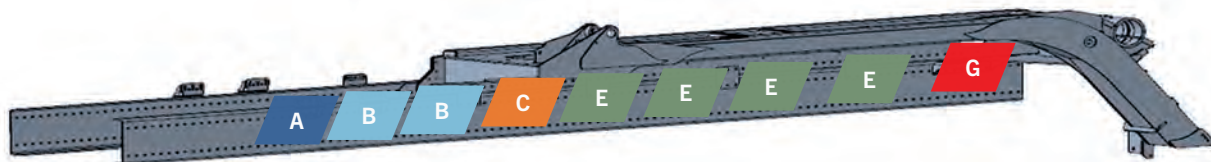

Diameter Durchmesser Diamètre (mm)	Length / Länge / Longueur (mm)					Nuts Nüsse Ecrus
	40	50	60	80	100	
Ø14	M9000464 (qty 50/box)	M9000465 (qty 50/box)	-	M9001032 (qty 25/box)	M9001033 (qty 25/box)	M9000463 qty (100/box)



#### ST 14 - 18

		A	B	C	D	E	F	G	Bolts / Schrauben / Visserie
				-	-		-		
M9001054	ST 14 - 18 < 4500 + screws / Schrauben / Visserie	x1	x1	-	-	x4	-	x1	
M9001055	ST 14 - 18 ≥ 4500 + screws / Schrauben / Visserie	x1	x1	-	-	x5	-	x1	
M9001052	ST 14 - 18 < 4500	x1	x1	-	-	x4	-	x1	
M9001053	ST 14 - 18 ≥ 4500	x1	x1	-	-	x5	-	x1	
Retailed kits Einzel Bausätze Kits au détail		-	-	-	-	M9000887	-	M9000523	

General accessories  
Allgemeines Zubehör  
Accessoires généraux

Hookloader  
Abrollkipper  
Polybenne

Skid loader  
Absetzkipper  
Multibenne

Retrofit kits  
Nachrüstungssätze  
Kits rétrofit

# SKIPLOADER MOUNTING KIT

## ABSETZKIPPER MONTAGEBAUSATZ

### MULTIBENNE KIT FIXATION

MAN TGA - TGS - TGX

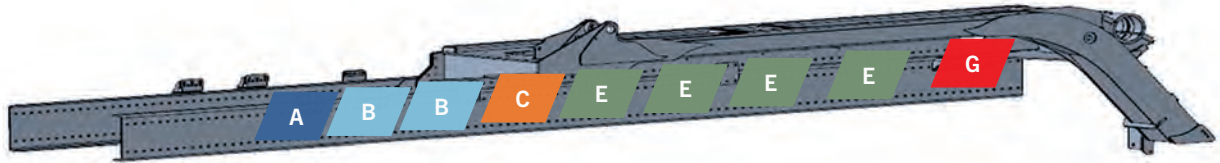

Diameter Durchmesser Diamètre (mm)	40	50	60	80	100	Nuts Nüsse Ecrus
---	----	----	----	----	-----	------------------------



Ø14

M9000464  
(qty 50/box)

M9000465  
(qty 50/box)

-

M9001032  
(qty 25/box)

M9001033  
(qty 25/box)

M9000463  
qty (100/box)

### ST 14 - 18

	A	B	C	D	E	F	G	Bolts / Schrauben / Visserie
--	---	---	---	---	---	---	---	------------------------------

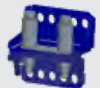

M9001058 ST 14 - 18 < 4500 + screws / Schrauben / Visserie x1 x1 x2 - x2 - x1 

M9001059 ST 14 - 18 ≥ 4500 + screws / Schrauben / Visserie x1 x1 x2 - x3 - x1 

M9001056 ST 14 - 18 < 4500 x1 x1 x2 - x2 - x1 

M9001057 ST 14 - 18 ≥ 4500 x1 x1 x2 - x3 - x1 

Retailed kits  
Einzel Bausätze  
Kits au détail - - - - M9000901 - M9000772 

## IVECO S WAY - X WAY

# IVECO

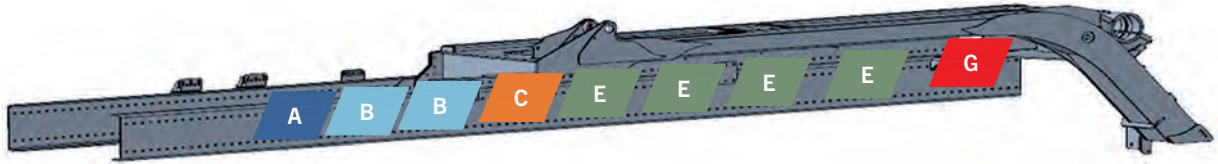

Diameter Durchmesser Diamètre (mm)	40	50	60	80	100	Nuts Nüsse Ecrus
---	----	----	----	----	-----	------------------------



Ø14	M9000464 (qty 50/box)	M9000465 (qty 50/box)	-	M9001032 (qty 25/box)	M9001033 (qty 25/box)	M9000463 qty (100/box)
-----	--------------------------	--------------------------	---	--------------------------	--------------------------	---------------------------

## ST 14 - 18

	A	B	C	D	E	F	G	Bolts / Schrauben / Visserie
--	---	---	---	---	---	---	---	------------------------------



M9001074	ST 14 - 18 < 4500 + screws / Schrauben / Visserie	x1	x2	x1	-	x2	-	x1	
M9001075	ST 14 - 18 ≥ 4500 + screws / Schrauben / Visserie	x1	x2	x1	-	x4	-	x1	
M9001072	ST 14 - 18 < 4500	x1	x1	x1	-	x2	-	x1	
M9001073	ST 14 - 18 ≥ 4500	x1	x1	x1	-	x4	-	x1	

**Retailed kits**  
Einzeln Bausätze  
Kits au détail

-	-	-	-	M9001131	-	M9000742	
---	---	---	---	----------	---	----------	--

General accessories  
Allgemeines Zubehör  
Accessoires généraux

Hookloader  
Abrollkipper  
Polybenne

Skipploader  
Absetzkipper  
Multibenne

Retrofit kits  
Nachrüstungssätze  
Kits rétrofit

# SKIPLOADER MOUNTING KIT

## ABSETZKIPPER MONTAGEBAUSATZ



### MULTIBENNE KIT FIXATION

MERCEDES ACTROS NEW, ANTOS & AROCS - SPRING SUSPENSION / *Stahlfederung* / *Suspension mécanique*



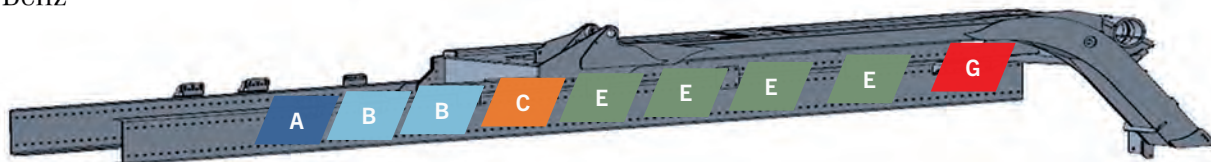









Mercedes-Benz



	Diameter Durchmesser Diamètre (mm)	Length / Länge / Longueur (mm)					Nuts Nüsse Ecrrous
		40	50	60	80	100	
	Ø14	M9000464 (qty 50/box)	M9000465 (qty 50/box)	-	M9001032 (qty 25/box)	M9001033 (qty 25/box)	M9000463 qty (100/box)
	Ø16	-	M9000505 (qty 50/box)	M9000506 (qty 50/box)	M9001128 (qty 25/box)	M9001129 (qty 25/box)	M9000507 (qty 100/box)

### ST 14 - 18

		A	B	C	D	E	F	G	Bolts / Schrauben / Visserie
					-		-		
M9001062	ST 14 - 18 < 4500 + screws / Schrauben / Visserie	x1	X1	x1	-	x3	-	x1	
M9001063	ST 14 - 18 ≥ 4500 + screws / Schrauben / Visserie	x1	x1	x1	-	x4	-	x1	
M9001060	ST 14 - 18 < 4500	x1	X1	x1	-	x3	-	x1	
M9001061	ST 14 - 18 ≥ 4500	x1	x1	x1	-	x4	-	x1	
<b>Retailed kits</b> <i>Einzeln Bausätze</i> <i>Kits au détail</i>		-	-	-	-	M9001130	-	M9000650	

# MERCEDES ACTROS NEW, ANTOS & AROCS - AIR SUSPENSION / Luftfederung / Suspension pneumatique



Mercedes-Benz

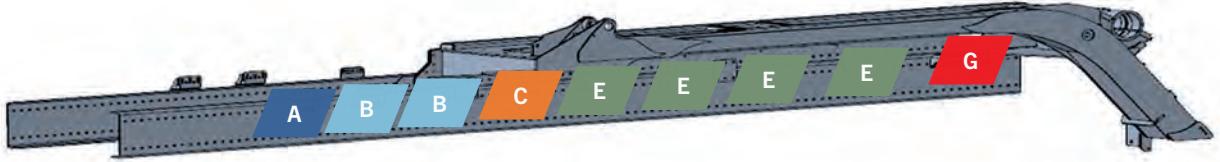

	Diameter Durchmesser Diamètre (mm)	Length / Länge / Longueur (mm)					Nuts Nüsse Ecrous
		40	50	60	80	100	
	Ø14	M9000464 (qty 50/box)	M9000465 (qty 50/box)	-	-	-	M9000463 qty (100/box)
	Ø16	-	M9000505 (qty 50/box)	M9000506 (qty 50/box)	-	-	M9000507 (qty 100/box)

## ST 14 - 18

		Bolts / Schrauben / Visserie							
		A	B	C	D	E	F	G	
M9001066	ST 14 - 18 < 4500 + screws / Schrauben / Visserie	x1	X1	x1	-	x4	-	x1	
M9001067	ST 14 - 18 ≥ 4500 + screws / Schrauben / Visserie	x1	x1	x1	-	x5	-	x1	
M9001064	ST 14 - 18 < 4500	x1	X1	x1	-	x4	-	x1	
M9001065	ST 14 - 18 ≥ 4500	x1	x1	x1	-	x5	-	x1	
<b>Retailed kits</b> Einzel Bausätze Kits au détail		-	-	-	-	M9000920	-	M9000523	

General accessories  
Allgemeines Zubehör  
Accessoires généraux

Hookloader  
Abrollkipper  
Polybenne

Skipploader  
Absetzkipper  
Multibenne

Retrofit kits  
Nachrüstungssätze  
Kits rétrofit



# SKIPLOADER MOUNTING KIT

## ABSETZKIPPER MONTAGEBAUSATZ



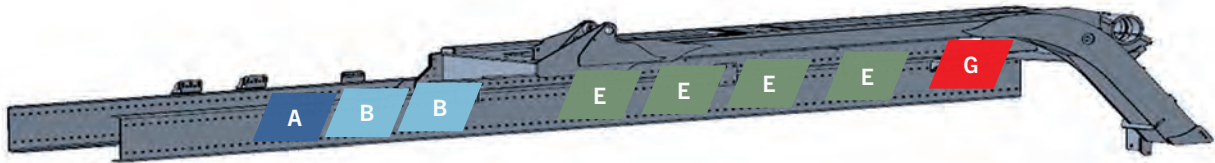







### MULTIBENNE KIT FIXATION

DAF XD-XF-XG 4X2 / 6X2 (← 2025/06)



Diameter Durchmesser Diamètre (mm)	Length / Länge / Longueur (mm)					Nuts Nüsse Ecrrous
	40	50	60	80	100	
 Ø14	M9000464 (qty 50/box)	M9000465 (qty 50/box)	-	M9001032 (qty 25/box)	M9001033 (qty 25/box)	M9000463 qty (100/box)
 Ø16	-	M9000505 (qty 50/box)	M9000506 (qty 50/box)	M9001128 (qty 25/box)	M9001129 (qty 25/box)	M9000507 (qty 100/box)

### ST 14 - 18

	A	B	C	D	E	F	G	Bolts / Schrauben / Visserie	
			-	-		-			
M9001078	ST 14 - 18 < 4500 + screws / Schrauben / Visserie	x1	x1	-	-	x4	-	x1	
M9001079	ST 14 - 18 ≥ 4500 + screws / Schrauben / Visserie	x1	x1	-	-	x6	-	x1	
M9001076	ST 14 - 18 < 4500	x1	x1	-	-	x4	-	x1	
M9001077	ST 14 - 18 ≥ 4500	x1	x1	-	-	x6	-	x1	
Retailed kits Einzel Bausätze Kits au détail	-	-	-	-	M9000944	-	M9000332		

## DAF XD-XFXG 4X2/6X2 (2025/06 →)



**Bolts are to be ordered separately**  
*Schrauben sind separat zu bestellen*  
 La visserie doit être commandée séparément

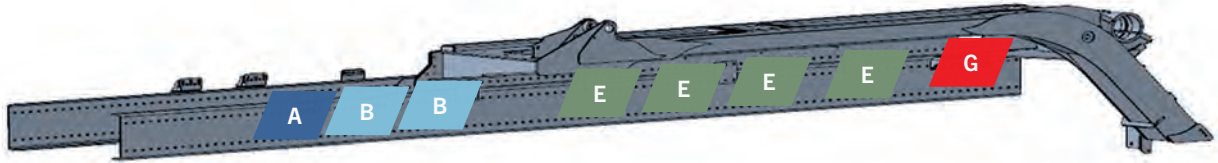

**Chassis drilling pattern 50 mm pitch - bolt diameter 14 mm**  
*Chassis Lochabstand 50 mm – Bolzendurchmesser 14 mm*  
 Perçage châssis pas de 50 mm – Diamètre boulon 14 mm

### BOLTS - SCHRAUBEN - VISSERIE

Part No.	Bolt Diameter	Length / Länge / Longueur (mm)					
		40	50	60	80	100	
M9001463	Ø14	M9000464 x1 (qty 50/box)	M9000465 x1 (qty 50/box)	-	M9001032 x1 (qty 25/box)	M9001033 x1 (qty 25/box)	M9000463 x2 (qty 100/box)

### ST 14 - 18

Part No.	Drilling Location			
	A	B	E	G
M9001482	x1	x2	x5	x1
<b>Retailed kits</b> <i>Einzel Bausätze</i> Kits au détail	M9001476	M9001477	M9001479	M9000650

General accessories  
 Allgemeines Zubehör  
 Accessoires généraux

Hookloader  
 Abrollkipper  
 Polybenne

Skipploader  
 Absetzkipper  
 Multibenne

Retrofit kits  
 Nachrüstungsätze  
 Kits retrofit

# SKIPLOADER MOUNTING KIT

## ABSETZKIPPER MONTAGEBAUSATZ

### MULTIBENNE KIT FIXATION

#### SCANIA P - R - G

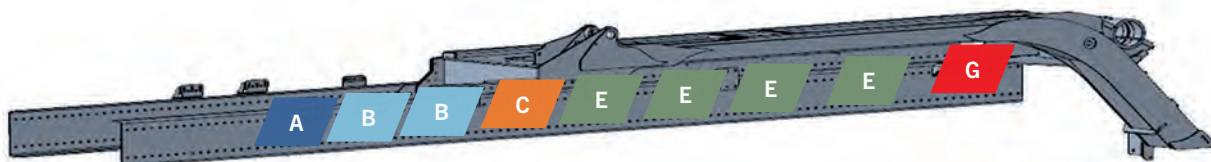

Diameter Durchmesser Diamètre (mm)	40	50	60	80	100	Nuts Nüsse Ecrus
---	----	----	----	----	-----	------------------------



Ø14	M9000464 (qty 50/box)	M9000465 (qty 50/box)	-	M9001032 (qty 25/box)	M9001033 (qty 25/box)	M9000463 qty (100/box)
-----	--------------------------	--------------------------	---	--------------------------	--------------------------	---------------------------

#### ST 14 - 18

	A	B	C	D	E	F	G	Bolts / Schrauben / Visserie
				-		-		

M9001070	ST 14 - 18 < 4500 + screws / Schrauben / Visserie	x1	x2	x1	-	x3	-	x1	
M9001071	ST 14 - 18 ≥ 4500 + screws / Schrauben / Visserie	x1	x2	x1	-	x4	-	x1	
M9001068	ST 14 - 18 < 4500	x1	x2	x1	-	x3	-	x1	
M9001069	ST 14 - 18 ≥ 4500	x1	x2	x1	-	x4	-	x1	
<b>Retailed kits</b> Einzel Bausätze Kits au détail		-	-	-	-	M9001122	-	M9000752	

# RETROFIT KITS

## NACHRÜSTUNGSSÄTZE

### KITS RÉTROFIT



General accessories  
Allgemeines Zubehör  
Accessoires généraux

Hookloader  
Abrollkipper  
Polybenne

Skiploader  
Absetzkipper  
Multibenne

Retrofit kits  
Nachrüstungssätze  
Kits rétrofit

# RETROFIT KITS HOOKLOADER

## NACHRÜSTUNGSSÄTZE ABROLLKIPPER

### KITS RÉTROFIT BRAS

**RAPID MOTION RETROFIT KIT / Eilgang nachrüstungssatz / Kit rétrofit pour vitesse rapide**

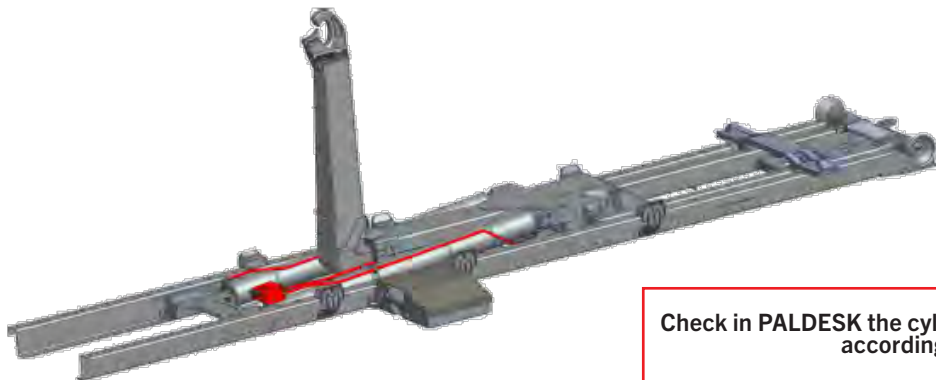

Check in **PALDESK** the cylinder dimension (Diameter and length) according to the equipment Nr

*Die Zylinderabmessungen (Durch und Länge) nach Gerät-Nr in Paldesk prüfen*

*Vérifier dans PALDESK les dimensions (Diamètre et longueur) en accord avec le n° d'équipement.*

### TELESCOPIC PH T / HT 18-24 (A) (ACTS)

	Kit size	XS	S	L
	Cylinder length		1708 mm 1715 mm	1873 mm 1880 mm
Internal Cylinder Diameter <i>Zylinderinnendurchmesser</i> Diamètre intérieur vérin	Ø140 mm	M9001152	M9001151	M9001148
	Ø150 mm	M9001190	M9001149	M9001146
	Ø160 mm	-	M9001150	M9001147



**ONLY AVAILABLE FOR SLD 5, TEC 5 & TEC**

### TELESCOPIC PH T (A) SCAN

	Kit size	S	L	XL
	Cylinder length		1873 mm 1880 mm	2128 mm 2135 mm
Internal Cylinder Diameter <i>Zylinderinnendurchmesser</i> Diamètre intérieur vérin	Ø140 mm	M9001182	M9001183	-
	Ø150 mm	M9001184	M9001185	M9001186
	Ø160 mm	M9001187	M9001188	M9001189



**ONLY AVAILABLE FOR SLD 5 or TEC 5 & TEC**

## ADD. FRONT LOCKING / Zusätzl. Hydraulische frontverriegelung / Verrouillage avant additionnel



### Contents:

**Add. hydr. section** / zusätzlicher Hydraulikabschnitt / Section hydr. additionnelle

**Body - hooks and cylinders** / Körper - Haken und Zylinder / Boitard - crochets et vérins

**Hoses and pipes** / Schläuche und Rohre / Flexibles et tubes

**Hydr. fittings** / Hydraulischer Anschluss / Raccords hydr.

**Electrical harness, sensors and rocker switch** / Elektrischer Kabelbaum, Sensoren und Schalter / Faisceaux électriques, capteurs et interrupteur

Unit type  
Gerätetyp  
Type d'équipement

Reference  
Referenz  
Référence

Telescopic  
Power  
Synchron

M9000680



**Order form available: Please contact your area sales manager**

Bestellformular verfügbar: Bitte kontaktieren Sie ihren Vertriebsmitarbeiter

Bon de commande disponible : Contactez votre animateur réseau

## COMPLEMENTARY KIT FRONT LOCK. / Frontverriegelung Ergänzungsset / Kit complémentaire verrouillage avant

### Contents:

**Body - hooks and cylinders** / Körper - Haken und Zylinder / Boitard - crochets et vérins

**Pipes** / Rohre / Tubes

**Hydr. fittings** / Hydraulischer Anschluss / Raccords hydrauliques

**Sensors** / Sensoren / Capteurs



Designation  
Bezeichnung  
Désignation

Unit type  
Gerätetyp  
Type d'équipement

Reference  
Referenz  
Référence

**Complementary kit front lock.**  
Frontverriegelung Ergänzungsset  
Kit complémentaire verrouillage avant

**NEW!**

**Complementary kit compact front lock.**  
Kompakt Frontverriegelung Ergänzungsset  
Kit complémentaire verrouillage avant compact

**NEW!**

HT 07 S - HT 08

M9001428

HT 18 - 24  
HP 17-20

M9001204

HT 26-30  
HP 24

M9001430

PH T (A) DINO

M9001205

PH T CHEM

M9001206

HT 18 - 24  
HP 17-20

M9001471

HT 26-30  
HP 24

M9001472

Hookloader option code required / Option für Abrollkipper erforderlich / Option nécessaire sur le bras: 3011

# RETROFIT KITS HOOKLOADER

## NACHRÜSTUNGSSÄTZE ABROLLKIPPER

### KITS RÉTROFIT BRAS

#### CONTROL SYSTEM / *Steuersystem* / *Système de commande*

Designation <i>Bezeichnung</i> Désignation	Application case <i>Anwendungsfall</i> Cas d'application	Reference <i>Referenz</i> Référence	Views <i>Aussicht</i> Vues
<b>Radio adaptation Kit for hooklift SDS150</b> <i>Funk Umbausatz für Abrollkipper SDS150</i> Kit adaptation radio pour bras SDS150	TEC	M9001199	 <div style="border: 1px solid red; padding: 5px; margin-top: 10px;"> <b>Also available as ex-factory</b>  <i>Verfügbar als ab Werk</i>            Egalement disponible sortie d'usine   <b>option 5401 / 5202 / 5203</b> </div>
<b>Radio adaptation Kit for hooklift SD08 + SDS180</b> <i>Funk Umbausatz für Abrollkipper SD08 + SDS180</i> Kit adaptation radio pour bras SD08 + SDS180	SLD 5 TEC 5	M9001200	

**PAD interface SDS 150**  
*PAD Anschluss SDS 150*  
 Interface PAD SDS 150

TEC  
SLD 5  
TEC 5

M9001284

**PAD interface SD 08 + SDS 180**  
*PAD Anschluss SD 08 + SDS 180*  
 Interface PAD SD 08 + SDS 180

TEC  
SLD 5  
TEC 5

M9001285

Product Info 2022/07



**SLD Crane - Crane interface monitoring**  
*SLD Kran - Kran Transportstellungs Schnittstelle*  
 Grue SLD - Interface surveillance grue

TEC \*  
TEC 5

M9001203

Product Info 2022/04

\* Screen to be ordered separately / *Schirm separat zu bestellen* / Écran à commander séparément



**Detection kit of RRC emitter in charging base**  
*Überwachungsatz für Funk Sender im Ladestation*  
 Détection émetteur radio dans son chargeur

M9001377



# RETROFIT KITS SKIPLoader

## NACHRÜSTSÄTZE ABSETZKIPPER

### KITS RÉTROFIT MULTIBENNE

#### TREATED LIFTING CHAINS / Beschichte Kettenaufhängung / Chaines de levage traitées

**COROLIM®**

**Protection against corrosion min 400h**

*Korrosionsschutz min 400 Stunden*

*Protection anticorrosion mini 400h*



	Designation <i>Bezeichnung</i> Désignation	Link Ø [mm] <i>Glied</i> Maillon	Unit capacity [t] <i>Hubkapazität</i> Capacité levage	Reference <i>Teil Nummer</i> Référence	Option code <i>Optionscode</i> Code option	Features <i>Eigenschaften</i> Caractéristiques
	<b>Lifting chain with self-locking hook</b> <i>Kettenaufhängung mit selbstverriegelnde Haken</i> <i>Chaîne de levage à crochet auto verrouillé</i>	13	8 - 14	M3021068	9625	
		16	16 - 18	M3021076	9625	
	<b>Lifting chain with skip suspension and safety latch</b> <i>Kettenaufhängung mit Einhandbedienung und Hakensicherheit</i> <i>Chaîne de levage avec anneau et linguet de sécurité</i>	13	8 - 14	M3021781	9610	
		16	16 - 18	M3021074	9610	
	<b>Secured chain shortener</b> <i>Kettenverkürzer mit Sicherheit</i> <i>Raccourcisseur de chaîne avec sécurité</i>	13	8 - 14	M3021073	9630	
		16	16 - 18	M3021078	9630	

#### LIFTING CHAINS / Kettenaufhängung / Chaines de levage

	Designation <i>Bezeichnung</i> Désignation	Link Ø [mm] <i>Glied</i> Maillon	Unit capacity [t] <i>Hubkapazität</i> Capacité levage	Reference <i>Teil Nummer</i> Référence	Option code <i>Optionscode</i> Code option	Features <i>Eigenschaften</i> Caractéristiques
	<b>Lifting chain with self-locking hook</b> <i>Kettenaufhängung mit selbstverriegelnde Haken</i> <i>Chaîne de levage à crochet auto verrouillé</i>	13	8 - 14	M3008885	9625	
		16	16 - 18	M3009536	9625	
	<b>Lifting chain with skip suspension and safety latch</b> <i>Kettenaufhängung mit Einhandbedienung und Hakensicherheit</i> <i>Chaîne de levage avec anneau et linguet de sécurité</i>	13	8 - 14	M3004966	9610	
		16	16 - 18	M3006590	9610	
	<b>Chain shortener</b> <i>Kettenverkürzer</i> <i>Raccourcisseur de chaîne</i>	13	8 - 14	M3004965	9607	
		16	16 - 18	M3002422	9607	
<b>Secured chain shortener</b> <i>Kettenverkürzer mit Sicherheit</i> <i>Raccourcisseur de chaîne avec sécurité</i>	13	8 - 14	M3009403	9630		
	16	16 - 18	M3009404	9630		

General accessories  
Allgemeines Zubehör  
Accessoires généraux

Hookloader  
Abrollkipper  
Polybenne

Skiploader  
Absetzkipper  
Multibenne

Retrofit kits  
Nachrüstungssätze  
Kits rétrofit

# RETROFIT KITS SKIPLoader

## NACHRÜSTUNGSSÄTZE ABSETZKIPPER

### KITS RÉTROFIT MULTIBENNE

#### TIPPING CHAIN / Kippkette / Chaîne de bennage

	Designation <i>Bezeichnung</i> Désignation	Ø [mm]	Capacity [t] <i>Kapazität</i> capacité	Reference <i>Referenz</i> Référence	Option code <i>Optionscode</i> Code option
	<b>Tipping chain</b> <i>Kippkette</i> Chaîne de bennage		<b>All</b> <i>Alle</i> Tous	<b>M2150778</b> <b>NEW!</b>	<b>9616</b>



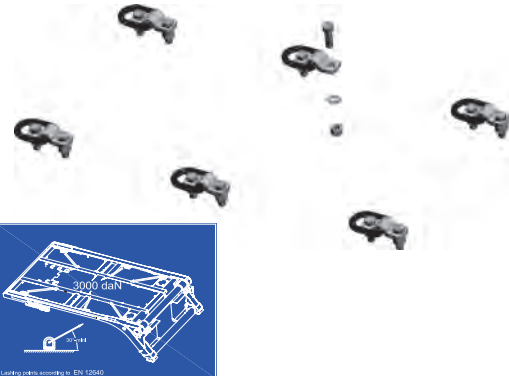

#### PULLING CHAIN / Ziehkette / Chaîne de traction

	Designation <i>Bezeichnung</i> Désignation	Ø [mm]	Capacity [t] <i>Kapazität</i> capacité	Reference <i>Referenz</i> Référence	Option code <i>Optionscode</i> Code option
	<b>Pulling chain with support</b> <i>Ziehkette mit Halter</i> Chaîne de traction avec support	<b>13</b>	<b>All</b> <i>Alle</i> Tous	<b>M2150776</b>	<b>9608</b>

#### MISCELLANEOUS/ Sonstiges / Divers

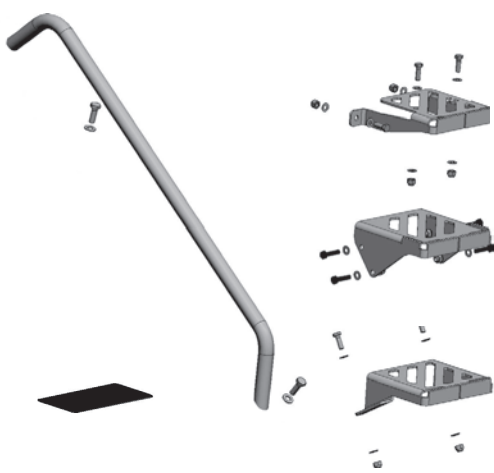
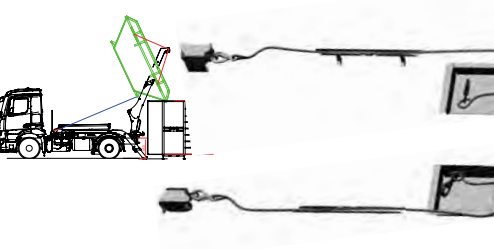
	Designation <i>Bezeichnung</i> Désignation	Reference <i>Referenz</i> Référence	 kg	Option code <i>Optionscode</i> Code option
	<b>6 Lashing rings kit + sticker</b> <i>Bausatz 6 Zurrösen + Sticker</i> Kit 6 anneaux d'arrimage + autocollant	<b>M9001036</b>	<b>11</b>	<b>9632</b>

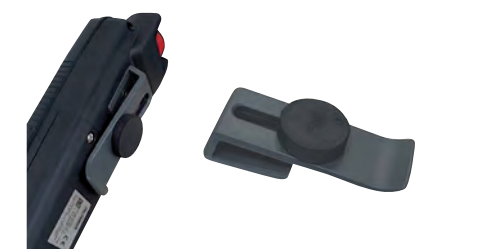
## MISCELLANEOUS/ Sonstiges / Divers

	Designation Bezeichnung Désignation	Reference Referenz Référence	kg	Option code Optionscode Code option
	<p><b>Rear access Right kit</b> Bausatz Heckzugang rechts Kit d'accessibilité Arrière droit</p>	M2150633	6	9634
	<p><b>Rear access Left kit</b> Bausatz Heckzugang links Kit d'accessibilité Arrière gauche</p>	M2150632	6	9633
	<p><b>High tipping only for ST TEC</b> Hochentleerung nur ST TEC Bennage en hauteur seulement pour ST TEC</p> <p><b>Rope version / Seil Version / Version à câble</b></p>	M9001468	-	9623
	<p><b>RRC Kit for P ST SLD 5</b> Funk Umbausatz für P ST SLD 5 Kit radio pour P ST SLD 5</p>	M9001201	-	5033
	<p><b>Magnet fixing for radio emitter</b> Magnetbefestigung für Funk Sender Fixation aimant pour émetteur radio</p>	M65031319	-	-

General accessories  
Allgemeines Zubehör  
Accessoires généraux

Hookloader  
Abrollkipper  
Polybenne

Skiploader  
Absetzkipper  
Multibenne

Retrofit kits  
Nachrüstungssätze  
Kits rétrofit



# GPA-MOUNTING INSTRUCTIONS

## GPA-MONTAGEANLEITUNG

## GPA-INSTRUCTIONS DE MONTAGE



Mounting Instructions available in Palfinger Extranet / Die Montageanleitungen sind im Palfinger Extranet verfügbar / Instructions de montage disponibles dans Palfinger Extranet: [PALDESK/Products/Service/Hooklift Europe/Installation guidelines](#)



Mounting Instructions available in Palfinger Extranet / Die Montageanleitungen sind im Palfinger Extranet verfügbar / Instructions de montage disponibles dans Palfinger Extranet: [PALDESK/Products/Service/Hooklift Europe/Installation guidelines / Truck Manufacturer Requirements](#)

**GUIMA PALFINGER SAS**

29 A, Avenue des Tourondes - BP 49  
82303 CAUSSADE - FRANCE



KP-MOUNTINGHOOKM6 09/2025

**Units shown in the leaflet are partially optional equipped and do not always correspond to the standard version. Country-specific regulations must be observed. Dimensions may vary. Subject to technical changes, errors and translation mistakes.**

*Die abgebildeten Geräte sind teilweise mit Wunschausrüstung ausgestattet und entsprechen nicht immer der Standardausführung. Beim Geräteaufbau sind länderspezifische Vorschriften zu beachten. Maßangaben unverbindlich. Technische Änderungen, Irrtümer und Übersetzungsfehler vorbehalten.*

Certains équipements en photos dans ce document sont dotés d'options et ne correspondent pas au modèle standard. Des réglementations nationales spécifiques relatives à la configuration sont à observer. Les dimensions ne revêtent pas un caractère contraignant. Sous réserve de modifications techniques, d'omissions et d'erreurs de traduction.